



Welcome Transfer Students!

College of Business and Economics

California State University, Los Angeles
College of Business and Economics
Student Services Center SH 256
5151 State University Drive | Los Angeles, CA 90032
T 323.343.2810 | cbestudentservices@calstatela.edu
www.calstatela.edu/business

The College of Business and Economics: AACSB Accredited



- AACSB (The Association to Advance Collegiate Schools of Business) seeks to promote quality education and we meet the AACSB's rigorous standards for program quality and continued improvement.
- Only **5%** of business schools worldwide have achieved AACSB international accreditation.

Top Ten Public Institutions in California

- CSULA's undergraduate business program has been listed among the nation's best in U.S. News & World Report's "America's Best Colleges."
- **TOP TEN public institutions in California** that made the list



College of Business & Economics

Major Options

BUSINESS ADMINISTRATION

(13 Options)

- **Accounting***
- **Business Economics**
- **Entrepreneurship**
- **Finance**
- **Human Resource Management**
- **International Business**
- **Marketing Management***
- **Management***
- **Operations Management**
- **Business Arts - Prelegal**
- **Real Estate**
- **Retailing**
- **Special Business**

COMPUTER

INFORMATION SYSTEMS (2 Options)

- **Information (Business) Systems**
- **Information Technology**

ECONOMICS (2 Options)

- **Applied Economics**
- **Social and Behavioral Sciences**

Impacted Options: Transfer Students

- **BSBA Accounting:**
 - Have a minimum cumulative college (transferable) GPA of 2.50.
 - Have a grade of C or above in the Lower Division Accounting courses: Acct 210 and Acct 211 or equivalent classes.

Impacted Options: Transfer Students

- **BSBA Management:**
 - Have a minimum cumulative college (transferable) GPA of 2.30.
- **BSBA Marketing:**
 - Have a minimum cumulative college (transferable) GPA of 2.25.

College of Business and Economics

Minors

A minor program allows students to focus on a specific area of interest:

- **Accounting** (24 units)
- **Computer Information Systems** (28 units)
- **Economics** (20 units)
- **Finance** (20 units)
- **Management** (20 units)
- **Real Estate** (20 units)
- **Entrepreneurship** (20 units)

What You Need to Graduate



General Education Courses

GENERAL EDUCATION LOWER DIVISION COURSES

| Block A Basic Subjects | American Institutions | Block B Natural Sciences | Block C Humanities | Block D Social Sciences | Block E Lifelong Understanding and Self-Development |
|--|--|--|---|---|--|
| 16 Units | 8 Units | 8 or 12 Units* | 8 or 12 Units* | 8 or 12 Units* | 4 Units |
| <p>*A1 WRITTEN COMM ENGL 101</p> <p>*A2 ORAL COMM COMM 150</p> <p>*A3 CRITICAL THINKING COMM 176 PHIL 160, 250 POLS 155</p> <p>*A4 MATHEMATICAL CONCEPTS AND QUANTITATIVE REASONING ECON / MATH 109, MATH 100, 102</p> <p><i>* Minimum C grade in these classes is required. A 'C-' grade is not acceptable.</i></p> | <p>US HISTORY HIST 202A or 202B</p> <p>U.S. CONSTITUTION +POLS 150</p> <p>STATE/LOCAL GOV'T +POLS 150 or 200</p> <p><i>+POLS 150 meets both areas</i></p> | <p>B1 BIOLOGICAL (with lab) BIOL 155, 156 MICR 151</p> <p>B2 PHYSICAL (with lab) ASTR 151 with 152 CHEM 158 with 159 GEOG 170 GEOL 150, 155 PHYS 156</p> <p>B3 APPLIED NATURAL ANTH 260 ASTR 160 BIOL 158 BIOL 165 CE 220 GEOG 160 GEOL 158</p> | <p>C1 LITERATURE AND DRAMA (d) CHS 201 ENGL 207, 250, 258, (d) 260, (d) 270, 280 SPAN 242 TA 152</p> <p>C2 ARTS ART 101ABC, 150, 152, 155, 156, 157, 159, (d) 209 CHS 112, (d) CHS/PAS 260 DANC 157 DANC / TA / TVF 210 ENGL / TVF 225 (d) LBS 234 MUS 150, 151, 152, 156, 157, 160</p> <p>C3 PHILOSOPHY AND RELIGIOUS STUDIES PHIL 151, 152 (d) PHIL / RELS 200 (d) PHIL 220</p> <p>C4 LANGUAGES OTHER THAN ENGLISH COMD 150 CHIN 100ABC, 200ABC FREN 100ABC, 200AB JAPN 100ABC, 130, 200ABC KOR 100ABC PAS 120 SPAN 100ABC, 105, 200ABC, 205ABC</p> <p>C-5 INTEGRATED HUMANITIES ENGL / TA / TVF 240 ENGL / PHIL 210</p> <p><i>(d) Approved diversity courses.</i></p> | <p>(d) AAAS 200 (d) ANTH 250 (d) BUS 250 CHDV 140 (d) CHS 111 (d) CHS / LAS 255 (d) CRIM 210 ECON 150 (d) GEOG 155 HIST 110ABC (d) HIST 150 (d) LAS / PAS 102 (d) PAS 180 PAS 250AB POLS 250 PSY 150 SOC 201 (d) SOC 263 (d) TVF 250 URBA 180 (d) WOMN 203</p> <p>INTEGRATED SOCIAL SCIENCES (d) LAS 150</p> <p><i>(d) Approved diversity courses.</i></p> | <p>*AL 101 ANTH 265 (d) ART 240 *BUS 101 BUS 200 (d) CHDV / SOC 120 COMM 230 *EDUC 101 *HHS 101 KIN 150 *NSS 101 PH 150 (d) PHIL 230 POLS 120 PSY 160 (d) SOC 202 TECH 250 *UNIV 101</p> <p><i>* Satisfies both IHE and Block E requirements</i></p> <p><i>(d) Approved diversity courses.</i></p> <p>Please refer below for Block F and G descriptions.</p> |
| <p>NOTES: Effective FALL Quarter 1998</p> <ul style="list-style-type: none"> A minimum C grade average in general education is required of all students following the 1987-89 or later catalog. Units in Blocks B, C, and D depend on major. See classification of majors in the <i>Schedule of Classes</i>. Other courses may be substituted in some categories in conjunction with a student's major. Consult a department or division adviser for a list of approved GE replacement courses. ENGL 102 is required of all students who entered Cal State L.A. Summer 1993 or later, and who are subject to the requirements of the 1993-95 or later GE catalog. A minimum C grade is required. A 'C-' grade is not acceptable. WPE – Writing Proficiency Exam is to be taken after completion of ENGL 102. Engineering and Computer Science majors' GE program differs. See an academic adviser in your major department. | | | | | |
| <p>Block F – Upper Division Theme (12 units). Students must complete one course in each of the three discipline areas (Natural Sciences, Social Sciences, and Humanities) as required in a theme. Completion of basic subjects requirements (Block A) and at least one course each from blocks B, C, and D are pre-requisites for Block F theme courses</p> | | | | | |
| <p>Block G – Diversity Requirement (2 courses) Students must complete two courses certified as diversity courses. Diversity courses are designated with a (d) by each course. These courses may be completed at either the general education lower division level in blocks C, D, E or upper division level from block F (the Theme). Diversity courses are required for students who are subject to Fall 1998 or later GE requirements.</p> | | | | | |

CSULA's
Lower
Division
GE's

General Education (GE) Certification

California Community Colleges offer 2 approved GE patterns for transfer:

- **CSU Breadth Requirements**
- **IGETC**

If you are not fully GE certified you may be held to Cal State L.A. GE requirements.

GE Certification can be FULL or PARTIAL

University Requirements



- **English 102**
 - Pass with “C” or better
- **Writing Proficiency Exam (WPE)**
 - Prerequisite: English 102
 - Must pass before reaching 135 units
- **Upper Division Themes**
 - 12 units from a Theme of your choice (A-I)
- **Diversity (*d*) Requirement**
 - 8 units



G.E. Upper Division Theme and Diversity Requirements

A. CHALLENGE OF CHANGE IN THE DEVELOPING WORLD

Coordinator: Msia Clark

This theme explores the dilemmas faced by the peoples of Africa, Asia, the Middle East and Latin America as they struggle to overcome legacies of colonialism and economic dependence. The developing countries are characterized by severe social and cultural tensions, physical complexities and challenges to themselves and the rest of the world. Their current integration into the global economy marks a crucial stage in world history. The natural courses assess their physical settings, constraints and possibilities; the social science courses analyze social, political and economic processes of change; the humanities component examines the dynamic interplay among arts, religion and cultural values.

12 units total

4 Units

Natural Sciences and Mathematics

- GEOG/GEOL 312, Global Climate Change and the Developing World (4)
- GEOG 333, Environment and Development in the Third World (4)
- GEOL 351, Environmental Geology of Developing Nations (4)
- PH 356, Issues in Global Health (4)

4 Units

Social Sciences

- COMM/LBS 395, Sociocultural Impact of Globalization for the Developing World (4)
- ECON 360, Developing Countries and the New Global Economy (4)
- HIST 360, Revolution and Society in Developing Countries (4)
- (d) LAS/PAS/POLS 360, Dynamics of Change in the Developing World (4)

4 Units

Humanities

- (d) LAS/PAS 342, Cultural Impact of Development (4)
- (d) MUS 358, Music of the Oppressed in Latin America (4)
- PHIL 334, Post-Colonial Values & Modernization in the Developing World (4)
- TVF 324, Third Cinema/Video (4)

| | '11 | W '12 | Sp '12 | Su '12 | F '12 | W '13 |
|----------------------|-----|-------|--------|--------|-------|-------|
| GEOG/GEOL 312 | D | | E | | D | |
| GEOG 333 | | E | | | | |
| GEOL 351 | | | | E | | |
| PH 356 | E | E | D | | E | |
| COMM/LBS 395 | | E | | E | | |
| ECON 360 | | D | | | D | |
| HIST 360 | E | B | D | | D | |
| (d) LAS/PAS/POLS 360 | E | B | B | E | E | |
| (d) LAS/PAS 342 | E | E | E | E | | |
| (d) MUS 358 | E | | E | | | |
| PHIL 334 | | | | | | |
| TVF 324 | | E | | D | | |



BS Business Administration Requirements

University Requirements

GE Theme
(3 classes)
+
2 Diversity (d)

ENGL 102

↓

WPE

↓

BUS 305

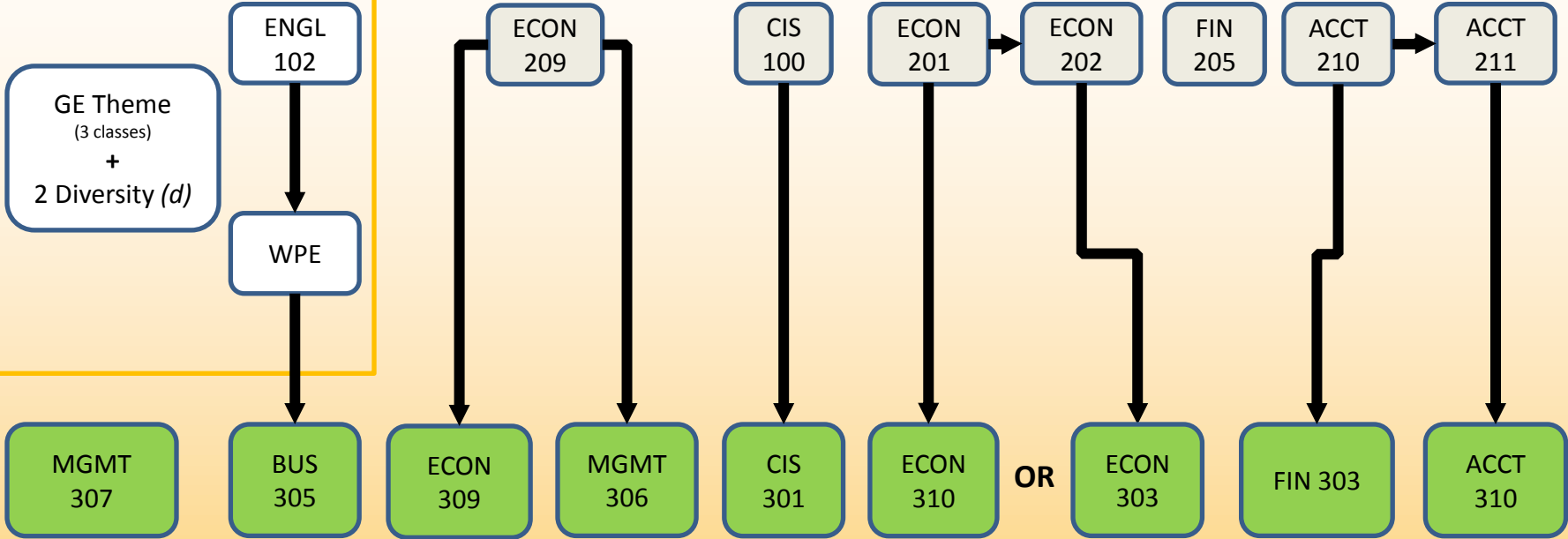

MGMT 497

(May only be taken after all other
core classes have been completed)

Option Courses

Please note that an additional 7 or 9 classes (28 or 36
units) for the option are not included in this flow chart.



B.S. Business Administration

Core Requirements

| LD Core BS Business Administration | |
|------------------------------------|--|
| ACCT 210 | Prin. of Financial Accounting (4) |
| ACCT 211 | Prin. of Managerial Accounting (4)- <i>Prereq: ACCT 210</i> |
| CIS 100 | Business Computer Systems (4) |
| ECON 201 | Prin. of Econ I: Microeconomics (4) |
| ECON 202 | Prin. of Econ II: Macroeconomics (4)- <i>Prereq: ECON 201</i> |
| ECON 209 | Applied Bus and Econ Statistics I (4) |
| FIN 205 | Legal and Reg Envrn of Bus I (4) |

| UD Core BS Business Administration | |
|--|---|
| ACCT 310 | Accounting Information for Decision Making- <i>Prereq: Acct 211</i> |
| BUS 305 | Business Communications- <i>Prereq: WPE</i> |
| CIS 301 | Management Information Systems- <i>Prereq: CIS 100</i> |
| ECON 303 | Money, Banking and the Economy- <i>Prereq: Econ 202</i> |
| OR | |
| ECON 310 | Economics of the Business Firm- <i>Prereq: Econ 201</i> |
| ECON 309 | Applied Business and Economic Statistics II <i>Prereq: Math 102 & Econ 209</i> |
| FIN 303 | Business Finance- <i>Prereq: Acct 210</i> |
| MGMT 306 | Production and Operations Management- <i>Prereq: Econ 209</i> |
| MGMT 307 | Management and Organizational Behavior |
| MGMT 308 | Business Responsibilities in Society |
| MKT 304 | Principles of Marketing |
| MGMT 497 | Capstone: Global Strategic Management* |
| *Capstone Course: Students must have completed all other required major CORE courses to enroll in MGMT 497 | |

BS Computer Information Systems Requirements

University Requirements

GE Theme
(3 classes)
+
2 Diversity (d)

ENGL 102

↓

WPE

↓

MGMT 307

BUS 305

MGMT 308

MKT 304

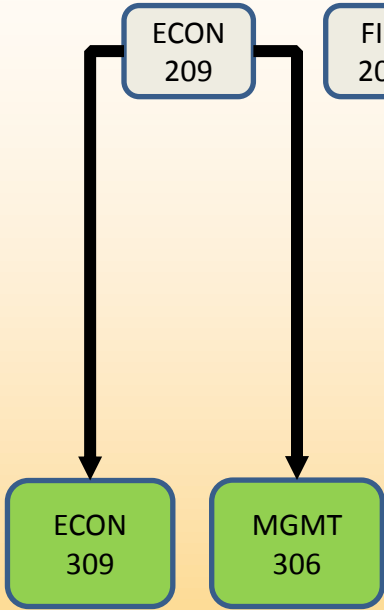

CIS 490
 (May only be taken after all other core classes have been completed)

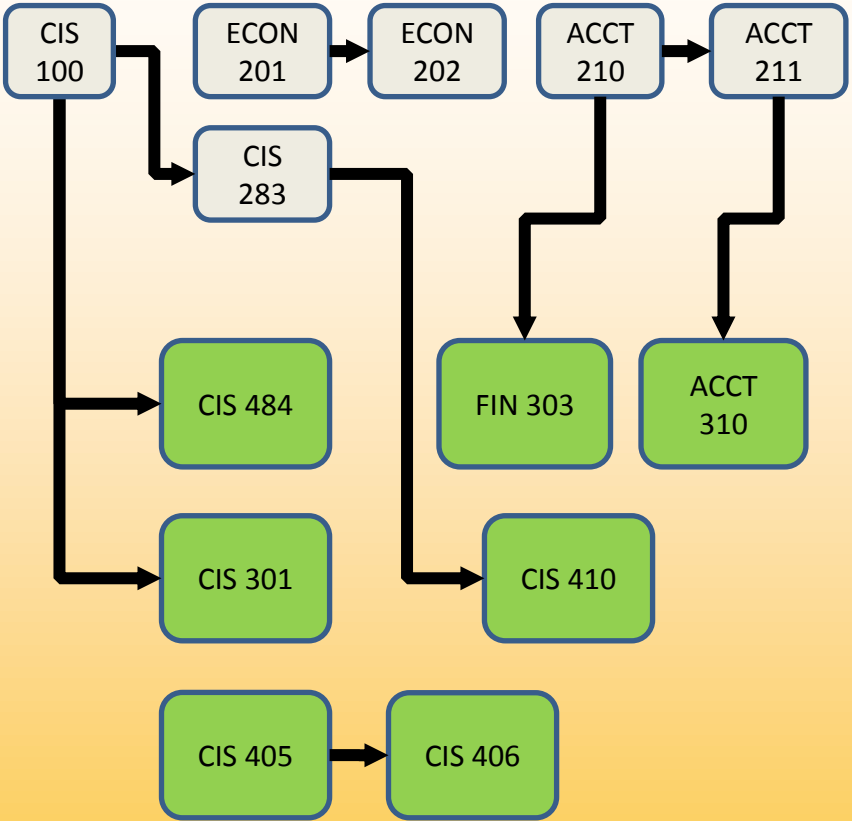

Option Courses
 Please note that an additional 5 classes (20 units) for the option are not included in this flow chart.



B.S. Computer Information Systems

Core Requirements

| LD Core BS Computer Information Systems | |
|---|--|
| ACCT 210 | Prin. of Financial Accounting (4) |
| ACCT 211 | Prin. of Managerial Accounting (4)- <i>Prereq: ACCT 210</i> |
| CIS 100 | Business Computer Systems (4) |
| ECON 201 | Prin. of Econ I: Microeconomics (4) |
| ECON 202 | Prin. of Econ II: Macroeconomics (4)- <i>Prereq: ECON 201</i> |
| ECON 209 | Applied Bus and Econ Statistics I (4) |
| FIN 205 | Legal and Reg Envrn of Bus I (4) |
| CIS 283 | Intro to Appl Progm with JAVA (4)- <i>Prereq: CIS 100</i> |

| UD Core BS Computer Information Systems | |
|---|---|
| ACCT 310 | Accounting Information for Decision Making- <i>Prereq: Acct 211</i> |
| BUS 305 | Business Communications- <i>Prereq: WPE</i> |
| CIS 301 | Management Information Systems- <i>Prereq: CIS 100</i> |
| CIS 405 | Database Design and Development |
| CIS 406 | Systems Analysis and Design- <i>Prereq: CIS 405</i> |
| CIS 410 | Hardware and Software Architecture- <i>Prereq: CIS 283</i> |
| CIS 484 | Communications Systems- <i>Prereq: CIS 100</i> |
| CIS 490 | Capstone: Information Systems* |
| ECON 309 | Applied Business and Economic Statistics II <i>Prereq: Math 102 & Econ 209</i> |
| FIN 303 | Business Finance- <i>Prereq: Acct 210</i> |
| MGMT 306 | Production and Operations Management- <i>Prereq: Econ 209</i> |
| MGMT 307 | Management and Organizational Behavior |
| MGMT 308 | Business Responsibilities in Society |
| MKT 304 | Principles of Marketing |

*Capstone Course: Students must have completed all other required major CORE courses to enroll in CIS 490

BA Economics Requirements Opt: Applied Economics

University Requirements

GE Theme
(3 classes)
+
2 Diversity (d)

ENGL 102

↓

WPE

↓

BUS 305
or
ENGL 306

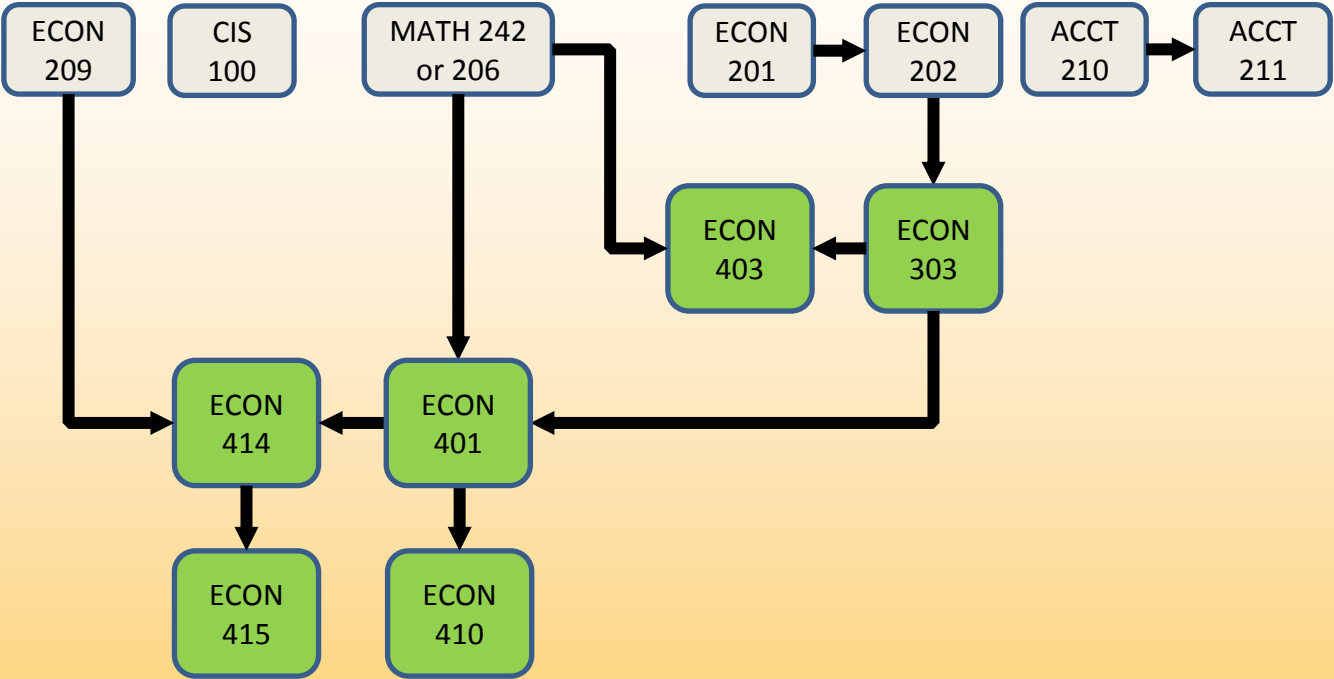

ECON 491
(May only be taken after all other core classes have been completed)

Elective Courses
Please note that an additional 7 classes (28 units) for the electives are not included in this flow chart.

BA Economics Requirements Opt: Social & Behavioral Economics

University Requirements

GE Theme
(3 classes)
+
2 Diversity (d)

ENGL 102

WPE

BUS 305
or
ENGL 306

ECON 209

ECON 309

MATH 242
or 206

ECON 201

ECON 310

ECON 403

ECON 410

ECON 202

ECON 303

ACCT 210

ACCT 211

ECON 401
(Not a required class, but
needed for ECON 410
prerequisite. Can be used
as 1 Elective)

Elective Courses

Please note that an additional 9 classes (36 units) for the electives are not included in this flow chart.

**Select Two In
This Box:**

B.A. Economics - Option Core Requirements

| LD Core BA Economics | |
|---------------------------------------|---|
| ACCT 210 | Prin. of Financial Accounting (4) |
| ACCT 211 | Prin. of Managerial Accounting (4)- <i>Prereq: ACCT 210</i> |
| CIS 100* | Business Computer Systems (4) |
| ECON 201 | Prin. of Econ I: Microeconomics (4) |
| ECON 202 | Prin. of Econ II: Macroeconomics (4)- <i>Prereq: ECON 201</i> |
| ECON 209 | Applied Bus and Econ Statistics I (4) |
| MATH 242 or 206 | Calculus for Bus and Econ Majors (4)- <i>Prereq: MATH 104A (MATH 104A&B for 206)</i> |
| <i>*Applied Economics Option only</i> | |

| UD Core BA Economics - Applied Economic Option | |
|---|--|
| ECON 303 | Money, Banking and the Economy- <i>Prereq: Econ 202</i> |
| Bus 305 OR ENGL 306 | Business Communications- <i>Prereq: WPE</i> Technical Writing- <i>Prereq: WPE</i> |
| ECON 401 | Mathematical Economics- <i>Prereq: Econ 303, Math 206 or 242</i> |
| ECON 403 | Macroeconomics- <i>Prereq: Math 242 or 206–207; Econ 303</i> |
| ECON 410 | Microeconomics- <i>Prereq: Econ 401</i> |
| ECON 414 | Econometrics I- <i>Prereq: Econ 209 & 401</i> |
| ECON 415 | Applied Economic and Business Forecasting <i>Prereq: Econ 309 or 414</i> |
| ECON 491 | Capstone: Data Analysis, Reporting, and Presentation* |
| <small>*Capstone Course: Students must have completed all other required major CORE courses to enroll in ECON 491</small> | |

| UD Core BA Economics - Social & Behavioral Economics Option | |
|---|--|
| ECON 303 | Money, Banking and the Economy- <i>Prereq: Econ 202</i> |
| Bus 305 OR ENGL 306 | Business Communications- <i>Prereq: WPE</i> Technical Writing- <i>Prereq: WPE</i> |
| ECON 309 | Applied Business and Economic Statistics II <i>Prereq: Math 102 & Econ 209</i> |
| <i>Select two from the following:</i> | |
| ECON 310 | Economics of the Business Firm- <i>Prereq: Econ 201</i> |
| ECON 403 | Macroeconomics- <i>Prereq: Math 242 or 206–207; Econ 303</i> |
| ECON 410 | Microeconomics- <i>Prereq: Econ 401</i> |

First Quarter Courses

REQUIRED

Upper Division
Themes &
Diversity

(3 courses)

REQUIRED

Major
Upper Division
Core Requirements

(11 courses)

If not already
completed,
must
complete:

REQUIRED

English
102

REQUIRED

Major
Lower Division
Core
Requirements

Registration Tips

- Pay your tuition 3 days before your registration date
- To add an open course with a pre-requisite, show unofficial transcripts to the department of the course for a permit
- Students who meet prerequisite issue can be put on waitlist
- Watch instructional videos on CSULA website:

<https://get.calstatela.edu/>

Student Responsibilities

- **You are solely responsible for knowing the graduation requirements you are accountable for**
 - All info is available on your Advisement Report, University Catalog (e-catalog) and university website
- **Use Advisement Report as a guiding/planning tool**
 - You are responsible for your own Education Plan
- **Appointments with advisors:**
 - **Appointments are necessary!**

College of Business & Economics Website

www.calstatela.edu/business/advisement

- Make an Appointment!
- Important Messages
- Placement Services Calendar
- Advising Information
- Department Contacts
- College/Major Forms
- Student Clubs

Advisement Report and Class Search

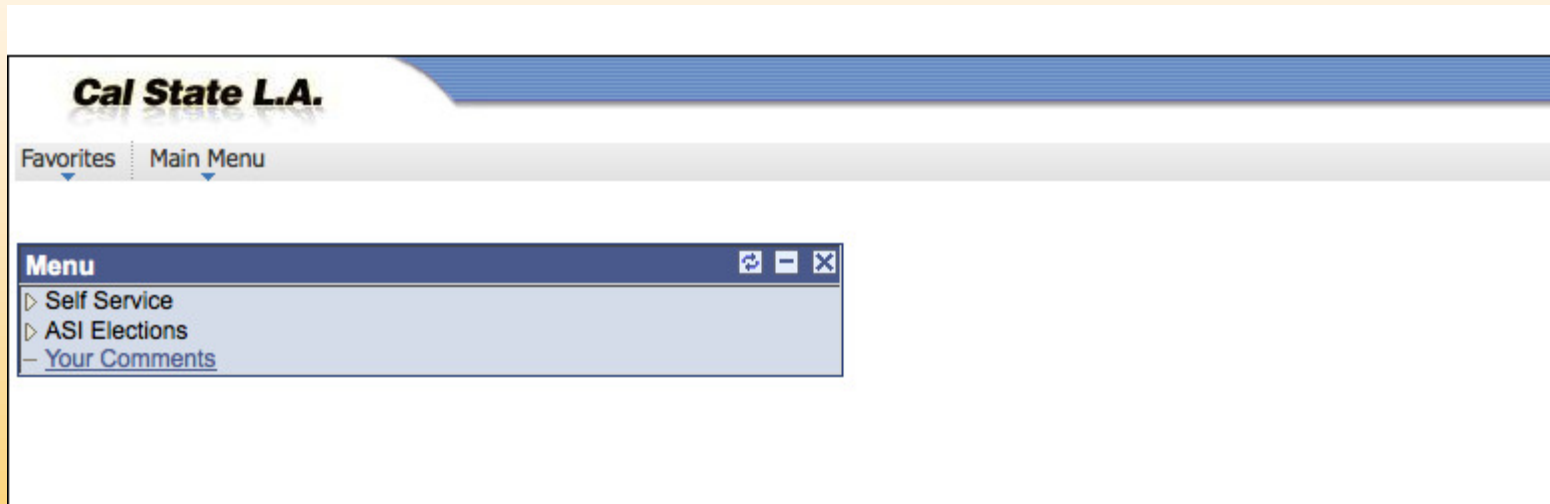

Self Service

Navigate to your self service information and activities.

 **[Student Center](#)**
Use the student center to manage school related activities.

 **[Class Search / Browse Catalog](#)**
Find classes that match your selection criteria, or browse the course catalog by subject.

- [Class Search](#)
- [Browse Course Catalog](#)

 **[Campus Personal Information](#)**
Maintain your personal information and review holds and to dos pending to your record.

- [Addresses](#)
- [Phone Numbers](#)
- [Email Addresses](#)
- [6 More...](#)

 **[Apply to Honors College](#)**
Apply to Honors College

 **[Enrollment](#)**
View appointments, plan and enroll in classes, view student and exam schedules.

- [Enrollment Dates](#)
- [My Class Schedule](#)
- [My Weekly Schedule](#)
- [4 More...](#)

 **[Academic Records](#)**
View grades and advisors and request transcripts and verification reports.

- [View Unofficial Transcript](#)
- [Major Program Info](#)

 **[Time Reporting](#)**
Report and review your time, schedules, request absences and more.

- [Report Time](#)
- [View Time](#)

 **[Campus Finances](#)**
View your account, make an electronic payment, view and accept aid awards.

- [Account Inquiry](#)
- [Accept/Decline Awards](#)
- [View Financial Aid](#)
- [View 1098-T](#)

Student Center

Academics

[Search](#)
[Enroll](#)
[My Academics](#)

[Deadlines](#) [URL](#) [Gradebook](#)

| This Week's Schedule | |
|----------------------------|----------------------------------|
| Class | Schedule |
| ECON 201-01 LEC (10149) | TuTh 1:30PM - 3:10PM SH E184 |
| FIN 205-02 LEC (11786) | TuTh 9:50AM - 11:30AM SH C136 |
| MKT 358-01 LEC (11943) | MoWe 1:30PM - 3:10PM SH C368 |

[weekly schedule ▶](#)

- other academic... ▼
- Academic Requirements
- Advisor Notes
- Class Schedule
- Enrollment: Add
- Enrollment: Drop
- Enrollment: Swap
- Grades
- Transcript: View Unofficial
- Withdrawals/Repeats
- other academic... ▼

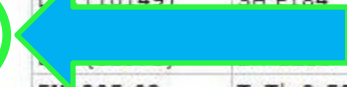

[SEARCH FOR CLASSES](#)

Holds
No Holds

To Do List
[Loan Entrance Counseling details ▶](#)

Enrollment Dates
Enrollment Appointment
You may begin enrolling for the Fall Quarter 2013 Regular Academic Session session on July 31, 2013.
[details ▶](#)

Important and Helpful Links
[Student Quarterly Dates](#)
[Common Req errors - help sheet](#)
[Make A Payment](#)

Additional Student Information
[Financial Aid Forms & Info](#)
[CSU EPT/ELM Scores Website!](#)
[Register to Vote](#)

Early Start Help
[Enroll in Early Start Classes](#)

Finances

My Account
[Account Inquiry](#)
[Enroll In Direct Deposit](#)

Financial Aid
[View Financial Aid](#)
[Accept/Decline Awards](#)

other financial... ▼

You have no outstanding charges at this time.

[*Important Student Fee Information](#) [Make a Payment](#)

Personal Information

[Demographic Data](#)
[Emergency Contact](#)
[User Preferences](#)

other personal... ▼

| Contact Information | |
|------------------------------|---|
| Home Address | Mailing Address |
| Home Phone | Personal Not CampusE-Mail |



Brenda Solorio

go to ... 

[Search](#) [Enroll](#) [My Academics](#)
search for classes | browse course catalog

Search for Classes

Enter Search Criteria

Search for Classes

Institution 

Term 
Select at least 2 search criteria to see search results.

Class Search

Subject

Course Number 

Course Career 

Show Open Classes Only

Additional Search Criteria

[Search](#) [Enroll](#) [My Academics](#)

[Search For Classes](#) [Browse Course Catalog](#)

go to ... 

Brenda Solorio

go to ... 

Search

Enroll

My Academics

search for classes

browse course catalog

Search for Classes

Enter Search Criteria

Search for Classes

Institution Cal State University, L.A. 

Term Fall Quarter 2014 

Select at least 2 search criteria. Click Search to view your search results.

Class Search

Subject select subject MGMT Management

Course Number is exactly  307

Course Career Graduate 

Show Open Classes Only

Additional Search Criteria

CLEAR

SEARCH

Brenda Solorio

go to ... 

Search

Enroll

My Academics

search for classes

browse course catalog

Search for Classes

Enter Search Criteria

Search for Classes

Institution ▾

Term ▾

Select at least 2 search criteria. Click Search to view your search results.

▼ Class Search

Subject Management

Course Number ▾

Course Career ▾

- ▶ **Additional Search Criteria**
- CalStateTeach
 - Continuing Education
 - Doctor of Education
 - English Language Program
 - Graduate
 - Quick Application Entry
 - Undergraduate

CLEAR

SEARCH

Search for Classes

Search Results

Cal State University, L.A. | Fall Quarter 2014

[My Class Schedule](#) show all

MGMT 500 We 6:10PM - 10:00PM
ST F412

[Shopping Cart](#)

Your shopping cart is empty.

The following classes match your search criteria Course Subject: **Management**, Course Number is exactly '306', Course Career: **Undergraduate**, Show Open Classes Only: **Yes**

Open
 Closed
 Wait List

3 class section(s) found

▼ MGMT 306 - OPERATIONS MANAGEMENT

| Class | Section | Days & Times | Room | Instructor | Meeting Dates | Status |
|-----------------------|--------------------------------|-----------------------|----------|------------|-------------------------|--------------------------------------|
| 11071 | 01-LEC Regular | MoWe 9:50AM - 11:30AM | SH C358B | Cheng Li | 09/25/2014 - 12/13/2014 | ● |

| Class | Section | Days & Times | Room | Instructor | Meeting Dates | Status |
|-----------------------|--------------------------------|---------------------|---------|---------------|-------------------------|--------------------------------------|
| 11180 | 05-LEC Regular | Mo 6:10PM - 10:00PM | SH C338 | Blair Berkley | 09/25/2014 - 12/13/2014 | ● |

| Class | Section | Days & Times | Room | Instructor | Meeting Dates | Status |
|-----------------------|--------------------------------|---------------------|---------|-----------------|-------------------------|--------------------------------------|
| 14867 | 08-LEC Regular | Th 6:10PM - 10:00PM | ST F412 | Mohsen Neghabat | 09/25/2014 - 12/13/2014 | ● |

NEW SEARCH

MODIFY SEARCH

Current Academic Objective

| | | <u>Requirement (Catalog) Term</u> |
|------------|-----------------------------|---------------------------------------|
| Career: | Undergraduate | Fall Quarter 2011 |
| Program: | Business & Economics | Summer Quarter 2013 |
| Plan(MAJ): | Bus Adm-BS-MKT | Summer Quarter 2013 |
| Sub-Plan: | Opt in Marketing Management | Summer Quarter 2013 |
| Degree: | BS | Summer Quarter 2013 |

Graduation Status: Not Applied

Current Academic Summary





| | |
|-----------------------|-------------------|
| Last Term Registered: | Fall Quarter 2013 |
| Academic Standing: | Good Standing |
| Overall GPA: | 2.754 |
| CSULA GPA: | 2.754 |

General Information

Below are the results of your Degree Progress Report. Should you have questions regarding the results, contact your academic adviser in your department or division.





Degree Audit Icons

Below are the symbols that tell you the status of each requirement.

| | |
|---|---------------------------|
|  | Requirement Satisfied |
|  | In Progress |
|  | Planned |
|  | Requirement Not Satisfied |
|  | Exception Made |

Course Icons

Source of credit

| | |
|--|------------------|
|  | Course Completed |
|  | In Progress |
|  | Planned |
|  | Transfer Credit |
|  | Simulation Only |

Current Academic Objective

1 of 2

| | | Requirement (Catalog Term) |
|---|-------------------------------|--|
| Career: | Undergraduate | Winter Quarter 2011 |
| Program: | Business & Economics | Winter Quarter 2011 |
| Plan(MAJ): | Computer Information Systems | Winter Quarter 2011 |
| Sub-Plan: | Opt in Information Technology | Winter Quarter 2011 |
| Degree: | BS | Winter Quarter 2011 |
| Expected Grad Term: Fall 2012 | | |
| Graduation Status: Initial Grad Check Reviewed | | |

Current Academic Summary





| | |
|-----------------------|---------------|
| Last Term Registered: | Summer 2012 |
| Academic Standing: | Good Standing |
| Overall GPA: | 2.406 |
| CSULA GPA: | 2.261 |

General Information

Below are the results of your Degree Progress Report. Should you have questions regarding the results, contact your academic adviser in your department or division.





Degree Audit Icons

Below are the symbols that tell you the status of each requirement.

| | |
|---|---------------------------|
|  | Requirement Satisfied |
|  | In Progress |
|  | Planned |
|  | Requirement Not Satisfied |
|  | Exception Made |

Course Icons

Source of credit

| | |
|---|------------------|
|  | Course Completed |
|  | In Progress |
|  | Planned |
|  | Transfer Credit |
|  | Simulation Only |

Cal State University, L.A. | Undergraduate

This report last generated on 01/24/2013 10:17AM

[collapse all](#)

[expand all](#)

UNIV UNIT & GPA REQUIREMENTS 

LD GE REQUIREMENTS 

G.E. UPPER DIVISION THEME 

UNGRADED COURSES

BADM BS CORE 

CIS BS CORE 

CIS BS OPT: INFORMATION TECH 

CIS BS OIFT MJR UNIT/GPA REQ 

▶ GE BLOCK AM CERTIFICATION 

GE BLOCK B NON NAT SCI 

GE BLOCK B NATURAL SCIENCE FOR NON-NATURAL SCIENCE BASED MAJORS [RQ 36]

- Units: 12.00 required, 8.00 taken, 4.00 needed

▼ GE B1B INTEGRATED LECTURE/LAB 

GE B1B - BIOLOGICAL (INTEGRATED LECTURE/LAB)

- Units: 4.00 required, 0.00 taken, 4.00 needed

▶ GE B2B INTEGRATED LECTURE/LAB 

▶ GE B3 INTERACTIONS 

The following courses may be used to satisfy this requirement:

| Course | Description | Units | When | Grade | Status |
|----------|--|-------|-------------------|-------|--------|
| FIN 205 | LEGAL+REGULAT ENVIRONMENT BUS | 4.00 | Fall Quarter 2010 | A- | ✓ |
| ACCT 210 | PRINCIPLES OF FINANCIAL ACCT | 4.00 | Fall Quarter 2010 | A | ✓ |
| ECON 209 | APPLIED BUS AND ECON STATISTIC | 4.00 | Fall Quarter 2010 | A | ✓ |
| ACCT 211 | PRINCIPLES OF MANAGERIAL ACCT | 4.00 | Fall 2012 | | ◆ |
| CIS 100 | BUSINESS COMPUTER SYSTEMS | 4.00 | Fall 2012 | | ◆ |
| ECON 201 | PRIN OF ECONOMICS I: MICRO | 4.00 | | | |
| ECON 202 | PRIN OF ECONOMICS II MACRO | 4.00 | | | |

View All | First 1-7 of 7 Last

BUSINESS UD CORE

UPPER DIVISION REQUIRED COURSES [RQ 4]

- Units: 44.00 required, 20.00 taken, 24.00 needed

▼ **UPPER DIVISION REQ'D COURSES**

REQUIRED UPPER DIVISION COURSES

- Units: 40.00 required, 20.00 taken, 20.00 needed

The following courses may be used to satisfy this requirement:

| Course | Description | Units | When | Grade | Status |
|----------|--|-------|-------------------|-------|--------|
| MGMT 308 | BUS RESPON IN SOC | 4.00 | Fall Quarter 2010 | A- | ✓ |
| CIS 301 | MANAGEMENT INFORMATION SYSTEMS | 4.00 | Winter 2013 | | ◆ |
| MGMT 306 | OPERATIONS MANAGEMENT | 4.00 | Winter 2013 | | ◆ |
| ECON 309 | APPLIED BUS AND ECON STAT II | 4.00 | Fall 2012 | | ◆ |
| MGMT 307 | MGMT+ORGANIZ BEH | 4.00 | Fall 2012 | | ◆ |
| ACCT 310 | ACCT INFO FOR DECISION MAKING | 4.00 | | | |
| BUS 305 | BUSINESS COMMUNICATIONS | 4.00 | | | |
| FIN 303 | BUSINESS FINANCE | 4.00 | | | |
| MGMT 497 | CAPSTONE: GLOBAL STRATEGIC MGM | 4.00 | | | |
| MKT 304 | PRIN OF MARKETING | 4.00 | | | |

View All | First 1-10 of 10 Last

OPTION REQUIREMENTS FOR FINANCE [RQ 84]

▼ REQ'D COURSES

REQUIRED OPTION COURSES

- Units: 16.00 required, 0.00 taken, 16.00 needed

The following courses may be used to satisfy this requirement:

| Course | Description | Units | When | Grade | Status |
|---------|--|-------|------|-------|--------|
| FIN 325 | ESSENTIAL SKILLS FOR FINAN PRO | 4.00 | | | |
| FIN 331 | FINANCL INST+MKTS | 4.00 | | | |
| FIN 332 | INVESTMENTS | 4.00 | | | |
| FIN 434 | CASES IN FINANCIAL MANAGEMENT | 4.00 | | | |

View All |  First  1-4 of 4  Last

▼ ELECTIVES

ELECTIVES

- Units: 12.00 required, 0.00 taken, 12.00 needed

The following courses may be used to satisfy this requirement:

| Course | Description | Units | When | Grade | Status |
|---------|--|-------|------|-------|--------|
| FIN 335 | PERSONAL PORTFOLIO AND RISK MG | 4.00 | | | |
| FIN 403 | INTERMEDIATE BUSINESS FINANCE | 4.00 | | | |
| FIN 431 | MULTINATIONAL FIN MGMT | 4.00 | | | |
| FIN 437 | SECURITIES ANALYSIS | 4.00 | | | |
| FIN 440 | FUTURES AND OPTIONS | 4.00 | | | |
| FIN 447 | STUDENT INVESTMENT FUND | 4.00 | | | |
| FIN 450 | FIXED INCOME SECURITIES:ANALY | 4.00 | | | |

View All |  First  1-7 of 7  Last

Declaring your Major Option on GET

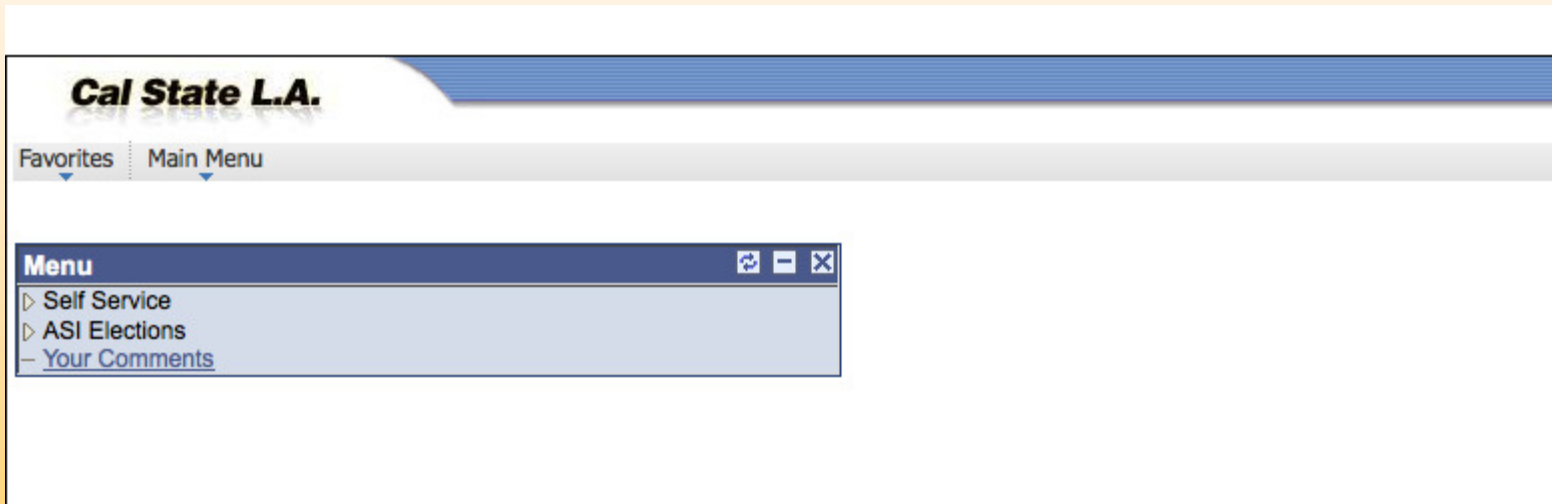



Self Service

Navigate to your self service information and activities.



[Student Center](#)

Use the student center to manage school related activities.



[Apply to Honors College](#)

Apply to Honors College



[Time Reporting](#)

Report and review your time, schedules, request absences and more.

[Report Time](#)

[View Time](#)



[Class Search / Browse Catalog](#)

Find classes that match your selection criteria, or browse the course catalog by subject.

[Class Search](#)

[Browse Course Catalog](#)



[Enrollment](#)

View appointments, plan and enroll in classes, view student and exam schedules.

[Enrollment Dates](#)

[My Class Schedule](#)

[My Weekly Schedule](#)

[4 More...](#)



[Campus Finances](#)

View your account, make an electronic payment, view and accept financial aid awards.

[Account Inquiry](#)

[Accept/Decline Awards](#)

[View Financial Aid](#)

[View 1098-T](#)



[Campus Personal Information](#)

Maintain your personal information and review holds and to dos pending to your record.

[Addresses](#)

[Phone Numbers](#)

[Email Addresses](#)

[6 More...](#)



[Academic Records](#)

View grades and advisors and request transcripts and verification reports.

[View Unofficial Transcript](#)

[Major Program Info](#)



Name:

ID:

Use this page to view your major and update/select your option (when applicable). Click on the magnifying glass to make your selection, click save when done. If a magnifying glass is not available, contact your major department to see if your major requires an option.

If you are an Undergraduate student and you have filed an application for graduation you cannot change your option on-line. Please see your major department for assistance in making this change.

If you are a Graduate student or pursuing a Credential you have the ability to only view your major information. For changes to your major and/or option or credential objective, please contact your major department for assistance.

| | |
|---|---|
| As of Term: | Fall Quarter 2013 |
| Career: | Undergraduate |
| College: | Business & Economics |
|  Major Program: | Bus Adm-BS-MKT |
| Option: | <input type="text"/>   |
| General Education (GE) Term: | Fall Quarter 2011 |
| Major Requirement Term: | Summer Quarter 2013 |

Save

If you are an Undergraduate student and you have filed an application for graduation you cannot change your option on-line. Please see your major department for assistance in making this change.

If you are a Graduate student or pursuing a Credential you cannot change your major information. For changes to your major and/or option please contact your major department for assistance.

As of Term: Fall Quarter 2013

Career: Undergraduate

College: Business & Economics

Major Program: Bus Adm-BS-MKT

Option: 

General Education (GE) Term: Fall Quarter 2011

Major Requirement Term: Summer Quarter 2013



Look Up

Look Up Option

Search by: Academic Sub-Plan begins with

[Advanced Lookup](#)

Search Results

View 100 First  1-4 of 4  Last

| Description |
|---|
| Opt in Entrepreneurship |
| Opt in International Business |
| Opt in Marketing Management |
| Opt in Retailing |



If you are a Graduate student or pursuing a Credential you have the ability to only view your major information. For changes to your major and/or option or credential objective, please contact your major department for assistance.

| | |
|-------------------------------------|--|
| As of Term: | Fall Quarter 2013 |
| Career: | Undergraduate |
| College: | Business & Economics |
| Major Program: | Bus Adm-BS-MKT |
| Option: | <input type="text" value="OMKMBADKBS"/>  Opt in Marketing Management |
| General Education (GE) Term: | Fall Quarter 2011 |
| Major Requirement Term: | Summer Quarter 2013 |



Other Important Offices on Campus

Student ID Card (must be enrolled):

Golden Eagle Service Center 220

Email/Password/GET:

ITS Help Desk, 1st floor Library, Palmer Wing

Financial Aid Office:

Student Affairs 124

Cashier's Office:

Administration 128

Campus Tours

Student Affairs 106



Planning for the future

- What's an IAP?
- Where do I find an IAP?
- How do I get help completing an IAP?

College of Business and Economics Student Services Center

Salazar Hall 256B

(323) 343-2810

Mon-Thu: 8:00am to 6:00pm

Friday: 8:00am to 5:00pm

Make an appointment:

www.calstatela.edu/business/advisement



If you have a quick question for an advisor, email us!

cbestudentservices@calstatela.edu