

Agilent 1000 Series Oscilloscopes

User's Guide



Agilent Technologies

Notices

© Agilent Technologies, Inc. 2008-2009

No part of this manual may be reproduced in any form or by any means (including electronic storage and retrieval or translation into a foreign language) without prior agreement and written consent from Agilent Technologies, Inc. as governed by United States and international copyright laws.

Manual Part Number

54130-97014

Edition

Second Edition, October 2009

Printed in Malaysia

Agilent Technologies, Inc.
1900 Garden of the Gods Road
Colorado Springs, CO 80907 USA

Warranty

The material contained in this document is provided “as is,” and is subject to being changed, without notice, in future editions. Further, to the maximum extent permitted by applicable law, Agilent disclaims all warranties, either express or implied, with regard to this manual and any information contained herein, including but not limited to the implied warranties of merchantability and fitness for a particular purpose. Agilent shall not be liable for errors or for incidental or consequential damages in connection with the furnishing, use, or performance of this document or of any information contained herein. Should Agilent and the user have a separate written agreement with warranty terms covering the material in this document that conflict with these terms, the warranty terms in the separate agreement shall control.

Technology Licenses

The hardware and/or software described in this document are furnished under a license and may be used or copied only in accordance with the terms of such license.

Restricted Rights Legend

U.S. Government Restricted Rights. Software and technical data rights granted to the federal government include only those rights customarily provided to end user customers. Agilent provides this customary commercial license in Software and technical data pursuant to FAR 12.211 (Technical Data) and 12.212 (Computer Software) and, for the Department of Defense, DFARS 252.227-7015 (Technical Data - Commercial Items) and DFARS 227.7202-3 (Rights in Commercial Computer Software or Computer Software Documentation).

Safety Notices

CAUTION

A **CAUTION** notice denotes a hazard. It calls attention to an operating procedure, practice, or the like that, if not correctly performed or adhered to, could result in damage to the product or loss of important data. Do not proceed beyond a **CAUTION** notice until the indicated conditions are fully understood and met.

WARNING

A **WARNING** notice denotes a hazard. It calls attention to an operating procedure, practice, or the like that, if not correctly performed or adhered to, could result in personal injury or death. Do not proceed beyond a **WARNING** notice until the indicated conditions are fully understood and met.

See also [Appendix A](#), “Safety Notices,” starting on page 151.

Agilent 1000 Series Oscilloscopes—At a Glance

The Agilent 1000 Series oscilloscopes are low-cost portable digital storage oscilloscopes (DSOs) that deliver these powerful features:

- Two and four-channel, 60 MHz, 100 MHz, and 200 MHz bandwidth models.
- Bright 5.7 inch QVGA (320 x 240) TFT color LCD display and small footprint (to save bench space).
- Up to 2 GSa/s sample rate.
- Up to 20 kpts memory.
- Up to 400 wfms/s refresh rate.
- Automatic voltage and time measurements (22) and cursor measurements.
- Powerful triggering (edge, pulse width, video, pattern, and alternate modes) with adjustable sensitivity (to filter noise and avoid false triggers).
- Math function waveforms: add, subtract, multiply, FFT.
- USB ports (2 host, 1 device) for easy printing, saving, and sharing of waveforms, setups, screen BMP files, and CSV data files.
- Internal storage for 10 waveforms and 10 setups.
- Special digital filter and waveform recorder.
- Built-in 6-digit hardware frequency counter.
- Multi-language (11) user interface menus and built-in help.

Table 1 Agilent 1000 Series Oscilloscope Models

	Input Bandwidth (Maximum Sample Rate, Memory)		
	200 MHz (1-2 GSa/s, 10-20 kpts)	100 MHz (1-2 GSa/s, 10-20 kpts)	60 MHz (1-2 GSa/s, 10-20 kpts)
4 channel	DS01024A	DS01014A	DS01004A
2 channel	DS01022A	DS01012A	DS01002A

In This Book

This guide shows how to use the Agilent 1000 Series oscilloscopes.

1 Getting Started

Describes the basic steps to take when first using the oscilloscope.

2 Displaying Data

Describes how to use the horizontal and vertical controls, channel settings, math waveforms, reference waveforms, and display settings.

3 Capturing Data

Describes acquisition modes and how to set up triggers.

4 Making Measurements

Describes voltage, time, and cursor measurements.

5 Saving, Recalling, and Printing Data

Describes how to save, recall, and print data.

6 Oscilloscope Utility Settings

Describes other oscilloscope settings found in the Utility menu.

7 Specifications and Characteristics

Describes the 1000 Series oscilloscopes' specifications and characteristics.

Contents

Agilent 1000 Series Oscilloscopes—At a Glance	3
In This Book	4
Figures	13
Tables	15
1 Getting Started	17
Step 1. Inspect the package contents	18
Step 2. Turn on the oscilloscope	19
Step 3. Load the default oscilloscope setup	20
Step 4. Input a waveform	21
	21
Step 5. Use Auto-Scale	22
Step 6. Compensate probes	24
Low Frequency Compensation	24
High Frequency Compensation	25
Step 7. Become familiar with the Front Panel Controls	26
Front Panel Overlays for Different Languages	27
Using the Oscilloscope Softkey Menus	28
Step 8. Become familiar with the oscilloscope display	30
Step 9. Use the Run Control keys	31
Step 10. Access the built-in help	32

Securing the Oscilloscope 33

2 Displaying Data 35

Using the Horizontal Controls 36

To adjust the horizontal scale 37

To adjust the horizontal position 38

To display the zoomed time base 39

To change the horizontal time base (Y-T, X-Y, or Roll) 40

To view the sample rate 42

Using the Vertical Controls 43

To turn waveforms on or off (channel, math, or reference) 43

To adjust the vertical scale 44

To adjust the vertical position 44

To specify channel coupling 45

To specify a bandwidth limit 47

To specify the probe attenuation 48

To use a digital filter 49

To change the Volts/Div control sensitivity 50

To invert a waveform 50

To specify the channel units 52

Using Math Function Waveforms 53

To add, subtract, or multiply waveforms 54

To display the frequency domain using FFT 54

Using Reference Waveforms 57

To save a reference waveform 57

To export or import reference waveforms 57

To return the reference waveform to its default scale 58

Changing the Display Settings	59
To display waveforms as vectors or dots	59
To clear the display	60
To set waveform persistence	60
To adjust waveform intensity	60
To display graded waveform intensity	61
To change the grid	61
To change the menu display time	62
To adjust the grid brightness	62
To invert screen colors	62
To select screen persistence	63
3 Capturing Data	65
Overview of Sampling	66
Sampling Theory	66
Aliasing	66
Oscilloscope Bandwidth and Sample Rate	67
Oscilloscope Rise Time	69
Oscilloscope Bandwidth Required	70
Real-Time Sampling	71
Memory Depth and Sample Rate	72
Choosing the Acquisition Mode	73
To select the Normal acquisition mode	73
To select the Average acquisition mode	74
To select the Peak Detect acquisition mode	75
To turn OFF/ON sine(x)/x interpolation	77
Recording/Playing-back Waveforms	78
To record waveforms	78
To play-back waveforms	79
To store recorded waveforms	81

Contents

Adjusting the Trigger Level	83
To adjust the trigger level	83
To force a trigger	84
Choosing the Trigger Mode	85
To set up edge triggers	85
To set up pulse width triggers	86
To set up video triggers	87
To set up pattern triggers	90
To set up alternate triggers	91
Setting Other Trigger Parameters	92
To set the trigger sweep	92
To set the trigger coupling	92
To set the trigger high-frequency reject coupling	93
To change the trigger sensitivity	94
To specify a trigger holdoff	95
Using the External Trigger Input	96
4 Making Measurements	97
Displaying Automatic Measurements	98
To display an automatic measurement	98
To clear automatic measurements from the display	99
To display or hide all automatic measurements	99
To select channels for delay/phase measurements	99

Voltage Measurements	100
Vmax (Maximum Voltage)	100
Vmin (Minimum Voltage)	101
Vpp (Peak-to-Peak Voltage)	101
Vtop (Top Voltage)	101
Vbase (Base Voltage)	101
Vamp (Amplitude Voltage = Vtop - Vbase)	101
Vavg (Average Voltage)	101
Vrms (Root-Mean-Square Voltage)	102
Overshoot	102
Preshoot	102
Time Measurements	103
Period	103
Frequency	104
Rise Time	104
Fall Time	104
Positive Pulse Width	105
Negative Pulse Width	105
Positive Duty Cycle	105
Negative Duty Cycle	105
Delay Between Rising Edges	106
Delay Between Falling Edges	106
Phase Between Rising Edges	107
Phase Between Falling Edges	107
Counter (Frequency)	108
Making Cursor Measurements	109
To use manually adjustable cursors	110
To use tracking cross-hair cursors	111
To display cursors for automatic measurements	112

5	Saving, Recalling, and Printing Data	113
	Saving and Recalling Data	114
	To save and recall waveforms	114
	To save and recall oscilloscope setups	115
	To save screens to BMP or PNG format files	116
	To save data to CSV format files	117
	Using the Disk Manager	118
	To switch between files, path, and directory panes	119
	To navigate the directory hierarchy	119
	To create new folders	119
	To edit folder/file names	120
	To delete folders	121
	To rename folders	121
	To delete files	121
	To recall files	122
	To rename files	122
	To display disk information	122
	Printing Screens	123
	To choose a PictBridge printer	124
	To print with inverted screen colors	125
	To choose color or grayscale printing	125
	To copy a screen to the printer	126
6	Oscilloscope Utility Settings	127
	Displaying System Information	128
	Turning Sound ON or OFF	128
	Setting and Displaying the Date and Time	129
	Setting the Language (Menu and Help)	130

Performing Mask Tests	131
To enable/disable mask tests	131
To select the source channel for mask tests	131
To run/stop a mask test	132
To turn on/off the mask test message display	132
To set the mask test output condition	133
To stop a mask test on the output condition	133
To set up masks	133
Setting Preferences	136
To set up the screen saver	136
To select the vertical scale reference level	136
To select the USB device port function	137
Running Self-Calibration	138
7 Specifications and Characteristics	139
Environmental Conditions	140
Overvoltage Category	140
Pollution Degree	140
Pollution Degree Definitions	140
Measurement Category	141
Measurement Category Definitions	141
Transient Withstand Capability	141
	141
Specifications	142
Characteristics	143
A Safety Notices	151
Warnings	151
Safety Symbols	152

Contents

Index 153

Figures

Figure 1. Power Switch	19
Figure 2. [Default Setup] Key	20
Figure 3. [Auto-Scale] Key	22
Figure 4. Low Frequency Probe Compensation	24
Figure 5. High Frequency Probe Compensation	25
Figure 6. Front Panel	26
Figure 7. Softkey Menus	28
Figure 8. Oscilloscope Display	30
Figure 9. Run Control Keys	31
Figure 10. [Help] Key	32
Figure 11. Securing the Instrument	33
Figure 12. Horizontal Controls	36
Figure 13. Status Bar, Trigger Position, and Horizontal Scale Control Indicators	37
Figure 14. Zoomed Time Base Window	40
Figure 15. X-Y Display Format Showing Out-of-Phase Waveforms	41
Figure 16. Vertical Controls	43
Figure 17. DC Coupling Control	46
Figure 18. AC Coupling Control	46
Figure 19. BW Limit Control OFF	47
Figure 20. BW Limit Control ON	48
Figure 21. Waveform Before Inversion	51
Figure 22. Waveform After Inversion	51
Figure 23. Math Scale Setting Value	53
Figure 24. FFT Waveform	56
Figure 25. [Display] Key	59
Figure 26. Aliasing	67
Figure 27. Theoretical Brick-Wall Frequency Response	68

Figures

Figure 28. Sample Rate and Oscilloscope Bandwidth	69
Figure 29. Real-Time Sampling Mode	71
Figure 30. Acquire Key	73
Figure 31. Noisy Waveform Without Averaging	74
Figure 32. Noisy Waveform With Averaging	75
Figure 33. Peak Detect Waveform	76
Figure 34. Trigger Controls	83
Figure 35. Line Synchronization	89
Figure 36. Field Synchronization	89
Figure 37. Alternate Triggers	91
Figure 38. Trigger Holdoff	95
Figure 39. [Measure] Key	98
Figure 40. Voltage Measurement Points	100
Figure 41. Period and Frequency Measurements	103
Figure 42. Rise Time and Fall Time Measurements	104
Figure 43. Positive Pulse Width and Negative Pulse Width Measurements	105
Figure 44. Delay Measurements	106
Figure 45. Phase Measurements	107
Figure 46. [Cursors] Key	109
Figure 47. USB Host Port on Front Panel	113
Figure 48. [Save/Recall] Key	114
Figure 49. Disk Manager	118
Figure 50. Editing Folder/File Names in Disk Manager	120
Figure 51. USB Ports on Back Panel	123
Figure 52. [Print] Key Location	124
Figure 53. [Utility] Key	127
Figure 54. Mask Test Display	132
Figure 55. Mask Test Mask Setting	134
Figure 56. Calibration Screen	138

Tables

Table 1. Agilent 1000 Series Oscilloscope Models	3
Table 2. Auto-Scale Default Settings	23
Table 3. Front Panel Controls	27
Table 4. FFT Window Characteristics	55
Table 5. Specifications	142
Table 6. Acquisition System Characteristics	143
Table 7. Vertical System Characteristics	143
Table 8. Horizontal System Characteristics	145
Table 9. Trigger System Characteristics	146
Table 10. Display System Characteristics	146
Table 11. Measurement Features	147
Table 12. FFT Measurement Features	147
Table 13. Storage	148
Table 14. I/O	148
Table 15. General Characteristics	149
Table 16. Power Requirements	149
Table 17. Environmental Characteristics	150
Table 18. Other	150

Tables



1 Getting Started

- Step 1. Inspect the package contents 18
- Step 2. Turn on the oscilloscope 19
- Step 3. Load the default oscilloscope setup 20
- Step 4. Input a waveform 21
- Step 5. Use Auto-Scale 22
- Step 6. Compensate probes 24
- Step 7. Become familiar with the Front Panel Controls 26
- Step 8. Become familiar with the oscilloscope display 30
- Step 9. Use the Run Control keys 31
- Step 10. Access the built-in help 32
- Securing the Oscilloscope 33

This chapter describes the basic steps to take when first using the oscilloscope.



Step 1. Inspect the package contents

1 Inspect the shipping container for damage.

Keep a damaged shipping container or cushioning material until you have inspected the contents of the shipment for completeness and have checked the oscilloscope mechanically and electrically.

2 Verify that you received the following items in the oscilloscope packaging:

- Oscilloscope.
- Power cord.
- N2862A 10:1 10 M Ω passive probes (60 MHz and 100 MHz models), quantity = number of oscilloscope channels.
- N2863A 10:1 10 M Ω passive probes (200 MHz model), quantity = number of oscilloscope channels.
- User's guide (this manual).
- Additional documentation and software CD.
- Front panel overlay (if language option other than English is chosen).

If anything is missing, or if you need to order additional probes, power cords, etc., contact your nearest Agilent Technologies sales office.

3 Inspect the oscilloscope.

- If there is mechanical damage or a defect, or if the oscilloscope does not operate properly or does not pass performance tests, notify your Agilent Technologies sales office.
- If the shipping container is damaged, or the cushioning materials show signs of stress, notify the carrier; then, contact your nearest Agilent Technologies sales office.

Keep the shipping materials for the carrier's inspection.

The Agilent Technologies sales office will arrange for repair or replacement at Agilent's option without waiting for claim settlement.

Step 2. Turn on the oscilloscope

The next few steps (turning on the oscilloscope, loading the default setup, and inputting a waveform) will provide a quick functional check to verify the oscilloscope is operating correctly.

1 Connect the power cord to a power source.

Use only power cords designed for your oscilloscope.

Use a power source that delivers the required power (see [Table 16](#) on page 149).

WARNING

To avoid electric shock, be sure the oscilloscope is properly grounded.

2 Turn on the oscilloscope.

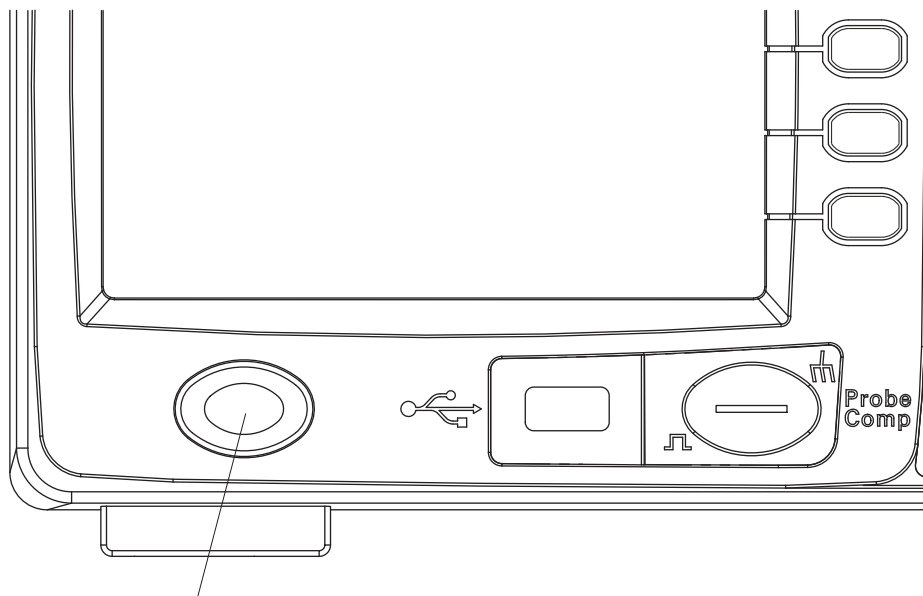

Figure 1 Power Switch

Step 3. Load the default oscilloscope setup

You can recall the factory default setup any time you want to return the oscilloscope to its original setup.

- 1 Press the front panel **[Default Setup]** key.

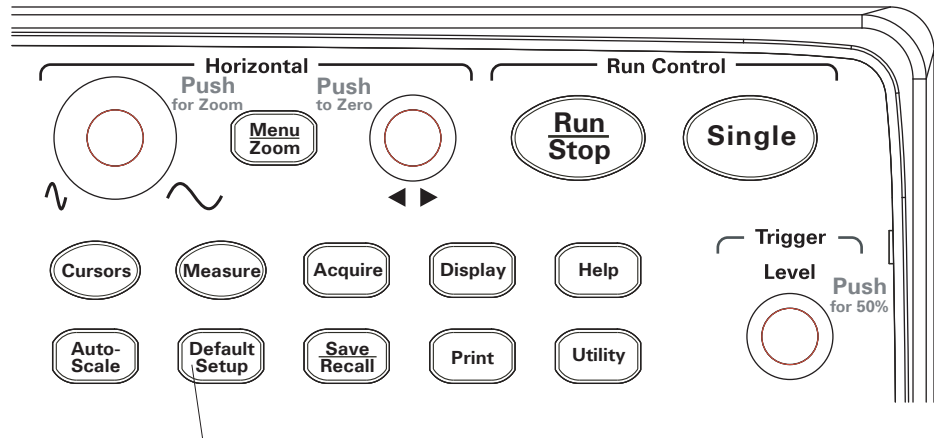

Figure 2 [Default Setup] Key

- 2 When the Default menu appears, press **[Menu On/Off]** to turn off the menu.
(The **Undo** softkey in the Default menu lets you cancel the default setup and go back to the previous setup.)

Step 4. Input a waveform

- 1 Input a waveform to a channel of the oscilloscope.

Use one of the supplied passive probes to input the Probe Comp signal from the front panel of the oscilloscope.

CAUTION

To avoid damage to the oscilloscope, make sure that the input voltage at the BNC connector does not exceed the maximum voltage (300 Vrms maximum).



Step 5. Use Auto-Scale

The oscilloscope has an auto-scale feature that automatically sets the oscilloscope controls for the input waveforms present.

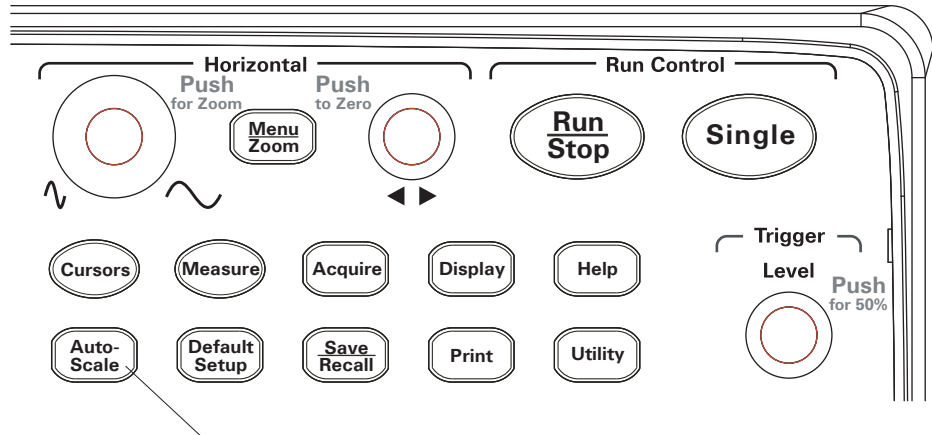

Figure 3 [Auto-Scale] Key

Auto-scale requires waveforms with a frequency greater than or equal to 50 Hz and a duty cycle greater than 1%.

- 1 Press the front panel [**Auto-Scale**] key.
- 2 When the AUTO menu appears, press [**Menu On/Off**] to turn off the menu.

The oscilloscope turns on all channels that have waveforms applied and sets the vertical and horizontal scales appropriately. It also selects a time base range based on the trigger source. The trigger source selected is the highest-numbered channel that has a waveform applied.

(The **Undo** softkey in the AUTO menu lets you cancel the auto-scale and go back to the previous setup.)

The oscilloscope is configured to the following default control settings:

Table 2 Auto-Scale Default Settings

Menu	Setting
Horizontal time base	Y-T (amplitude vs. time)
Acquisition mode	Normal
Vertical coupling	Adjusted to AC or DC according to the waveform.
Vertical "V/div"	Adjusted
Volts/Div	Coarse
Bandwidth limit	OFF
Waveform invert	OFF
Horizontal position	Center
Horizontal "S/div"	Adjusted
Trigger type	Edge
Trigger source	Measure the channel with input waveform automatically.
Trigger coupling	DC
Trigger voltage	Midpoint setting
Trigger sweep	Auto

Step 6. Compensate probes

Compensate probes to match your probe to the input channel. You should compensate a probe whenever you attach it for the first time to any input channel.

Low Frequency Compensation

For the supplied passive probes:

- 1 Set the Probe menu attenuation to 10X. If you use the probe hooktip, ensure a proper connection by firmly inserting the tip onto the probe.
- 2 Attach the probe tip to the probe compensation connector and the ground lead to the probe compensator ground connector.
- 3 Press the **[Auto-Scale]** front panel key.

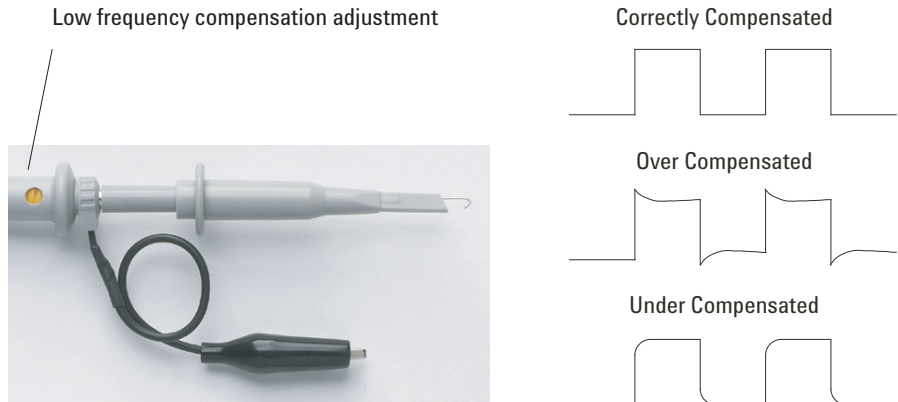

Figure 4 Low Frequency Probe Compensation

- 4 If waveform does not appear like the Correctly Compensated waveform shown in [Figure 4](#), then use a nonmetallic tool to adjust the low frequency compensation adjustment on the probe for the flattest square wave possible.

High Frequency Compensation

For the supplied passive probes:

- 1 Using the BNC adapter, connect the probe to a square wave generator.
- 2 Set the square wave generator to a frequency of 1 MHz, an amplitude of 3 V_{p-p}, and an output termination of 50Ω.
- 3 Press the **[Auto-Scale]** front panel key.

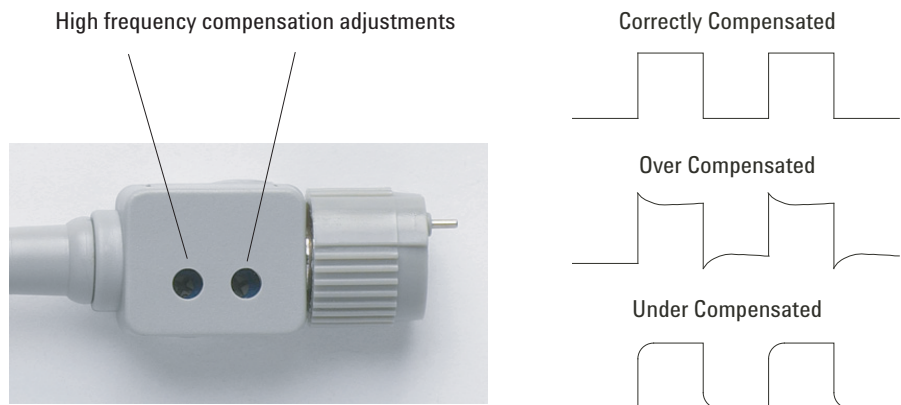

Figure 5 High Frequency Probe Compensation

- 4 If waveform does not appear like the Correctly Compensated waveform shown in [Figure 5](#), then use a nonmetallic tool to adjust the 2 high frequency compensation adjustments on the probe for the flattest square wave possible.

Step 7. Become familiar with the Front Panel Controls

Before using the oscilloscope, familiarize yourself with the front panel controls.

The front panel has knobs, keys, and softkeys. Knobs are used most often to make adjustments. Keys are used for run controls and to change other oscilloscope settings via menus and softkeys.

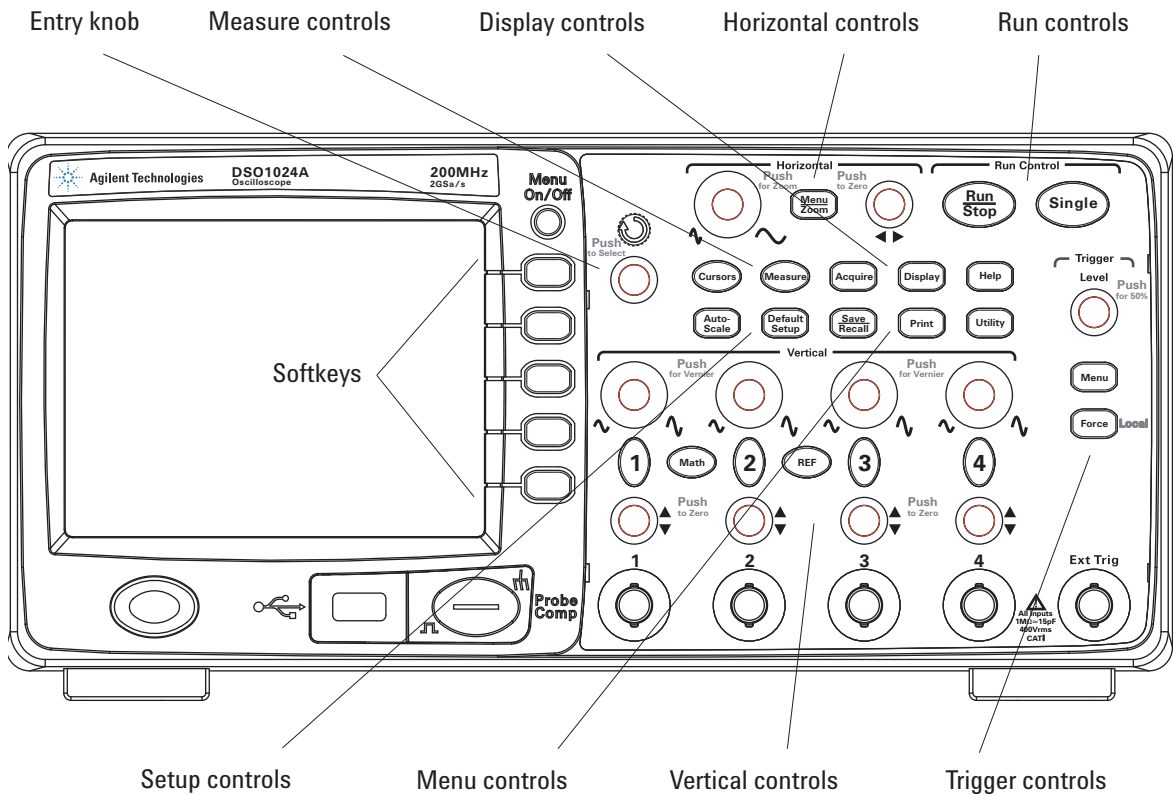



Figure 6 Front Panel

The definitions of the front panel knobs, keys, and softkeys are as follows:

Table 3 Front Panel Controls

Controls	Consists of these knobs and keys
Measure controls	[Measure] and [Cursors] front panel keys.
Waveform controls	[Acquire] and [Display] front panel keys.
Menu controls	[Save/Recall] and [Utility] front panel keys.
Vertical controls	Vertical position knobs, vertical scale knobs, channel ([1], [2], etc.) [Math], and [REF] front panel keys.
Horizontal controls	Position knob, [Menu/Zoom] front panel key, and scale knob.
Trigger controls	Trigger [Level] knob, [Menu], and [Force] front panel keys.
Run controls	[Run/Stop] and [Single] front panel keys.
Setup controls	[Auto-Scale] and [Default Setup] front panel keys.
Softkeys	Five gray keys from top to bottom on the right-hand side of the screen, which select the adjacent menu items in the currently displayed menu.
 entry knob	For the adjustment defined controls.

Front Panel Overlays for Different Languages

If you choose a language option other than English, you get a front panel overlay for your language option.

To install a front panel overlay:

- 1 Insert the tabs on the left side of the overlay into the appropriate slots on the front panel.
- 2 Gently press the overlay over the knobs and buttons.
- 3 When the overlay is against the front panel, insert the tabs on the right side of the overlay into the slots on the front panel.
- 4 Let the overlay flatten out. It should remain secure on the front panel.

Using the Oscilloscope Softkey Menus

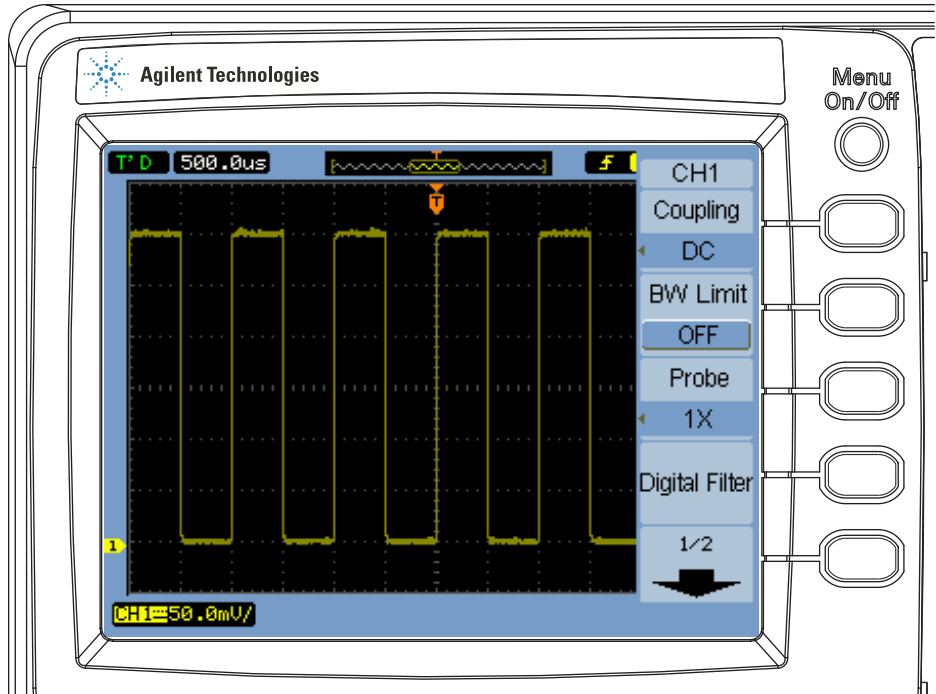

Figure 7 Softkey Menus

When one of the oscilloscope front panel keys turns on a menu, you can use the five softkeys to choose items from the menu.

Some common menu item choices are:



Accesses the next page of items in the menu.



Accesses the previous page of items in the menu.



Returns to the previous menu in the hierarchy.

The [**Menu On/Off**] front panel key turns off the menu or turns on the last accessed menu on again. The **Menu Display** item in the Display menu lets you select the amount of time menus are displayed (see “[To change the menu display time](#)” on page 62).

Step 8. Become familiar with the oscilloscope display

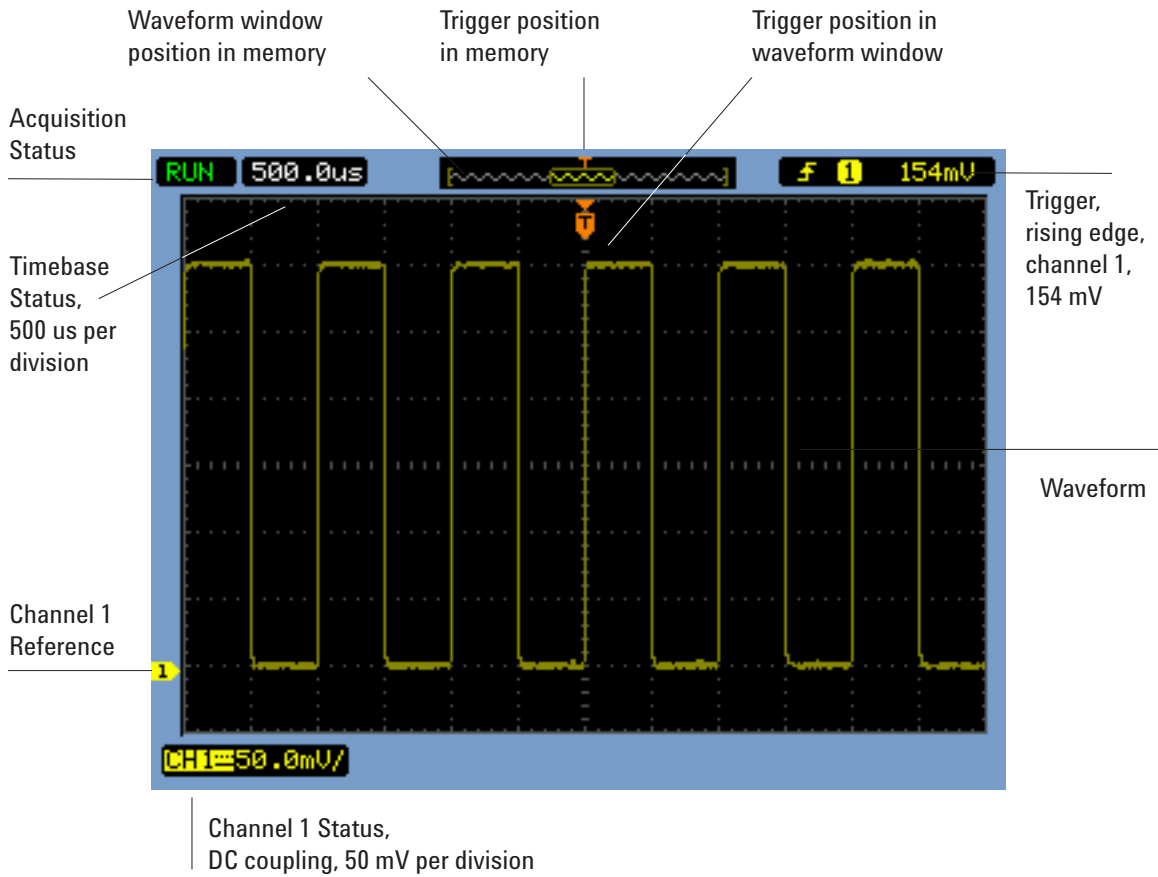

Figure 8 Oscilloscope Display

Step 9. Use the Run Control keys

There are two front panel keys for starting and stopping the oscilloscope's acquisition system: **[Run/Stop]** and **[Single]**.

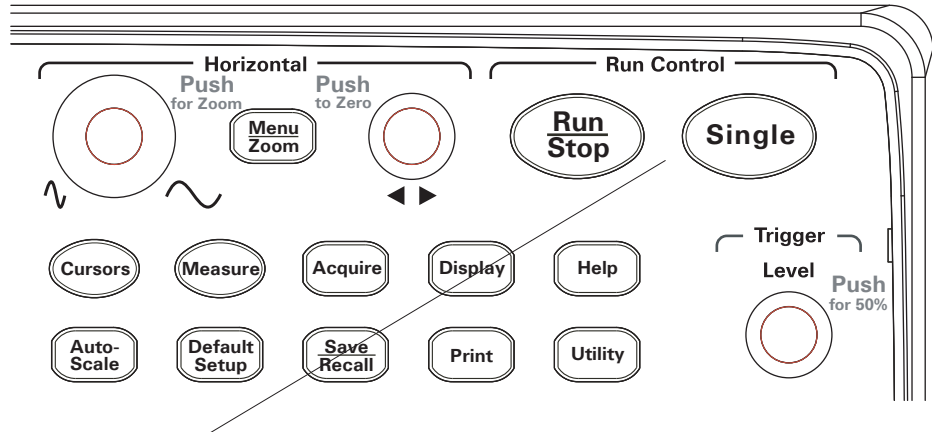

Figure 9 Run Control Keys

- When the **[Run/Stop]** key is green, the oscilloscope is acquiring data. To stop acquiring data, press **[Run/Stop]**. When stopped, the last acquired waveform is displayed.
- When the **[Run/Stop]** key is red, data acquisition is stopped. To start acquiring data, press **[Run/Stop]**.
- To capture and display a single acquisition (whether the oscilloscope is running or stopped), press **[Single]**. After capturing and displaying a single acquisition, the **[Run/Stop]** key is red.

Step 10. Access the built-in help

The oscilloscope has built-in quick help information. To access the built-in help:

- 1 Press the **[Help]** front panel key.

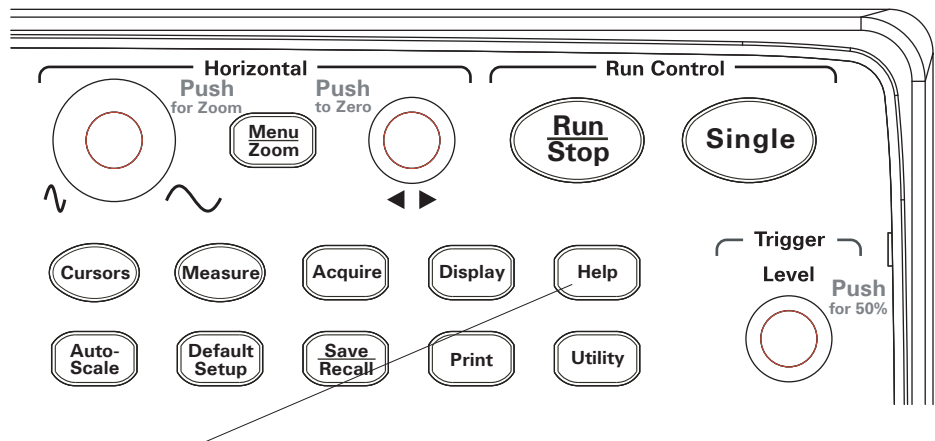

Figure 10 [Help] Key

- 2 Press the front panel key, softkey, or pushable knob on which you would like quick help information.

The built-in help is available in 11 different languages (see [“Setting the Language \(Menu and Help\)”](#) on page 130).

Securing the Oscilloscope

To secure a 1000 Series oscilloscope to its location, you can use a Kensington lock or the security loop.

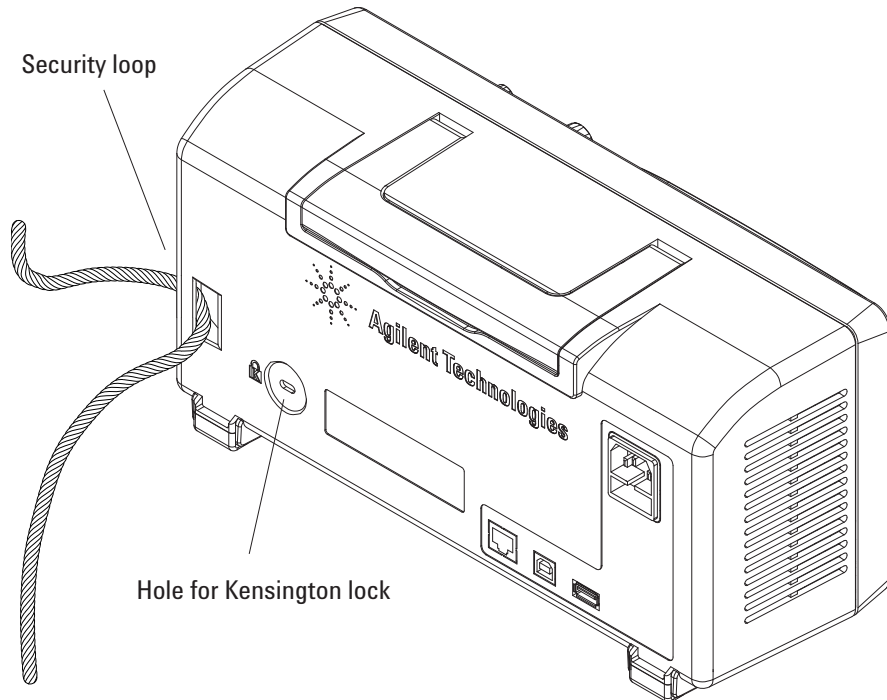
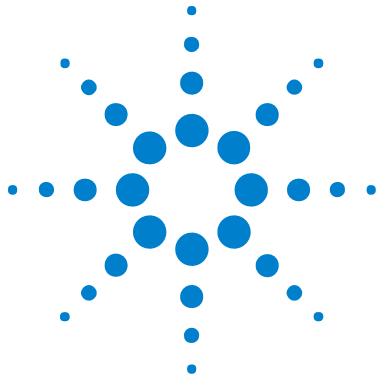

Figure 11 Securing the Instrument



2 Displaying Data

Using the Horizontal Controls	36
Using the Vertical Controls	43
Using Math Function Waveforms	53
Using Reference Waveforms	57
Changing the Display Settings	59

This chapter describes how to use the horizontal and vertical controls, channel settings, math waveforms, reference waveforms, and display settings.



Using the Horizontal Controls

The horizontal controls consist of:

- The horizontal scale knob – changes the oscilloscope’s time per division setting using the center of the screen as a reference.
- The horizontal position knob – changes the position of the trigger point relative to the center of the screen.
- The [Menu/Zoom] key – displays the Horizontal menu which lets you display the zoomed (delayed) time base, change the time base mode, and display the sample rate.

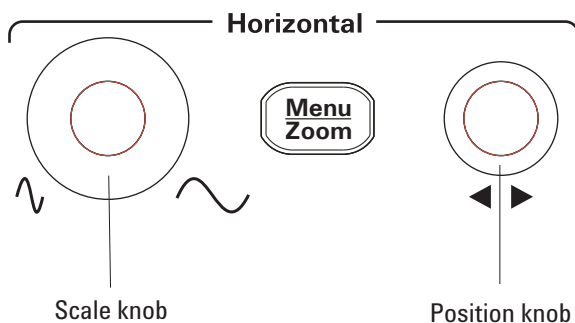

Figure 12 Horizontal Controls

Figure 13 shows the screen icon descriptions and control indicators.

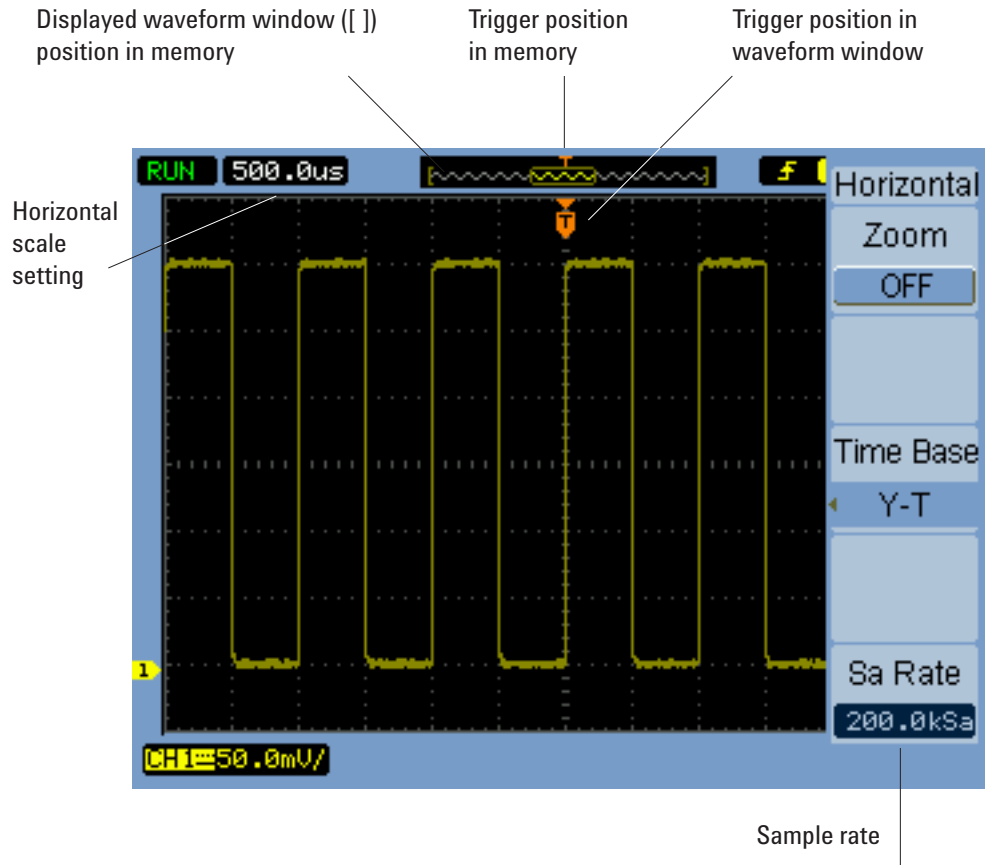

Figure 13 Status Bar, Trigger Position, and Horizontal Scale Control Indicators

To adjust the horizontal scale

- Turn the horizontal scale knob to change the horizontal time per division (time/div) setting (and the oscilloscope’s sample rate – see “Memory Depth and Sample Rate” on page 72).

The time/div setting changes in a 1-2-5 step sequence.

The time/div setting is also known as the *sweep speed*.

When the time/div is set to 50 ms/div or slower, the oscilloscope enters Slow Scan mode (see “[Slow Scan Mode](#)” below).

When the horizontal scale is set to 20 ns or faster, the oscilloscope uses sine(x)/x interpolation to expand the horizontal time base.

- Push the horizontal scale knob to toggle between the zoomed time base and the normal time base display (see “[To display the zoomed time base](#)” on page 39).

The time/div setting is displayed in the status bar at the top left of the screen. Because all channels are displayed in the same time base (except in the Alternate trigger mode), the oscilloscope displays one time/div setting for all channels.

Slow Scan Mode

When the horizontal scale is set to 50 ms/div or slower, the oscilloscope enters Slow Scan mode.

In the Slow Scan mode, peak detect acquisition is used so that no data is missed (even though the Acquire menu may show a different acquisition mode setting). The oscilloscope acquires sufficient data for the pre-trigger part of the display, then waits for the trigger. When the trigger occurs, the oscilloscope continues to capture data for the post-trigger part of the display.

When using the Slow Scan mode to view low frequency signals, the channel coupling should be set to “DC”.

The Slow Scan mode lets you see dynamic changes (like the adjustment of a potentiometer) on low frequency waveforms. For example, Slow Scan mode is often used in applications like transducer monitoring and power supply testing.

To adjust the horizontal position

- Turn the horizontal position knob to change the position of the trigger point relative to the center of the screen.

The position knob adjusts the horizontal position of all channels, math functions, and reference waveforms.

- Push the horizontal position knob to “zero” the trigger point (in other words, move it to the center of the screen).

To display the zoomed time base

The zoomed time base (also known as delayed sweep time base), magnifies a portion of the original waveform display (now on the top half of the screen) and displays it in a zoomed time base on the bottom half of the screen.

- 1 To toggle the zoomed time base “ON” or “OFF”, either push the horizontal scale knob or press [**Menu/Zoom**] key followed by the **Zoom** softkey in the Horizontal menu.
- 2 When the zoomed time base is “ON”:
 - The top half of the display shows the original waveform and the portion being magnified.
 - The horizontal scale knob changes the magnification (widens or narrows the area of magnification).
 - The horizontal position knob moves the area of magnification forward and backward on the original waveform.
 - The bottom half of the display shows the magnified data in the zoomed time base.

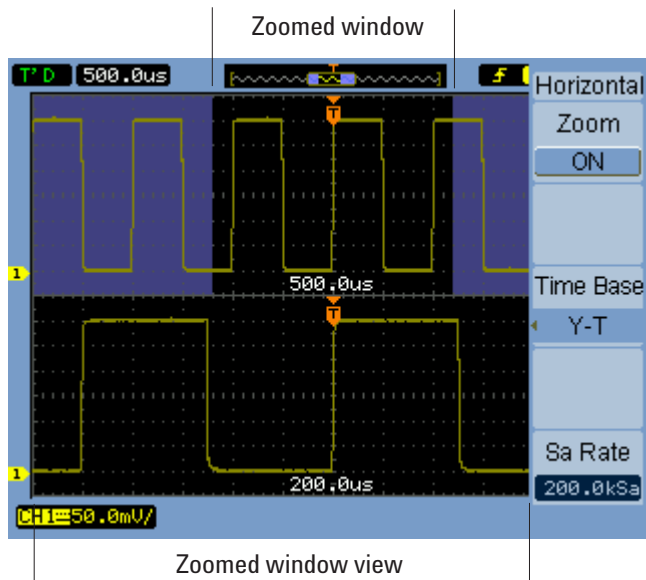



Figure 14 Zoomed Time Base Window

To change the horizontal time base (Y-T, X-Y, or Roll)

- 1 Press [Menu/Zoom].
- 2 In the Horizontal menu, press **Time Base**.
- 3 Continue pressing the **Time Base** softkey or turn the  entry knob to select between:

Y-T	Amplitude vs. time. This is the typical horizontal time base setting.
X-Y	Channel 2 (X-axis) vs. Channel 1 (Y-axis), see “ X-Y Format ” on page 41.

Roll In Roll mode, the waveform display rolls from right to left, and the minimum horizontal scale setting is 500 ms/div. No trigger or horizontal position control is available. Roll mode is used in applications similar to the ones for which Slow Scan mode is used (see “[Slow Scan Mode](#)” on page 38).

X-Y Format

This format compares the voltage level of two waveforms point by point. It is useful for studying phase relationships between two waveforms. This format only applies to channels 1 and 2. Choosing the X-Y display format displays channel 1 on the horizontal axis and channel 2 on the vertical axis.

The oscilloscope uses the untriggered sample acquisition mode and waveform data is displayed as dots. The sampling rate can vary from 4 kSa/s to 100 MSa/s, and the default sampling rate is 1 MSa/s.



Figure 15 X-Y Display Format Showing Out-of-Phase Waveforms

2 Displaying Data

The following modes or functions are not available in X-Y format:

- Automatic voltage or time measurements.
- Cursor measurements.
- Mask testing.
- Math function waveforms.
- Reference waveforms.
- Zoomed time base display.
- Displaying waveforms as vectors.
- Horizontal position knob.
- Trigger controls.

To view the sample rate

- 1 Press [**Menu/Zoom**].
- 2 In the Horizontal menu, the **Sa Rate** menu item displays the sample rate used for the current horizontal scale setting.

See Also [“Memory Depth and Sample Rate”](#) on page 72.

Using the Vertical Controls

The vertical controls consist of:

- The channel ([1], [2], [3], and [4]), [Math], and [REF] front panel keys – turn waveforms on or off (and display or hide their menus).
- The vertical scale knobs – change the amplitude per division setting for a waveform, using either ground or the center of the screen as a reference (depending on a preference setting).
- The vertical position knobs – change the vertical position of the waveform on the screen.

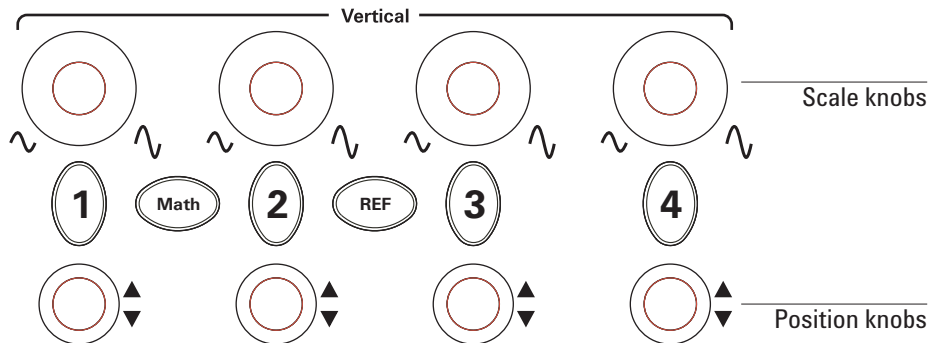

Figure 16 Vertical Controls

To turn waveforms on or off (channel, math, or reference)

Pressing the channel ([1], [2], [3], and [4]), [Math], and [REF] front panel keys have the following effect:

- If the waveform is off, the waveform is turned on and its menu is displayed.
- If the waveform is on and its menu is not displayed, its menu will be displayed.
- If the waveform is on and its menu is displayed, the waveform is turned off and its menu goes away.

To adjust the vertical scale

When an input channel waveform is on:

- Turn its vertical scale knob to change the amplitude per division setting.

The amplitude/div setting changes in a 1-2-5 step sequence from 2 mV/div to 5 V/div (with “1X” probe attenuation).

Either ground or the center of the screen is used as a reference, depending on the “Expand Reference” preference setting (see “[To select the vertical scale reference level](#)” on page 136). The “center of screen” reference is not available for math function or reference waveforms.

- Push its vertical scale knob to toggle between vernier (fine scale) adjustment and normal adjustment.

With vernier adjustment, the amplitude/div setting changes in small steps between the normal (coarse scale) settings.

The **Volts/Div** item in a channel’s menu also toggles between vernier and normal adjustment (see “[To change the Volts/Div control sensitivity](#)” on page 50).

Vernier adjustment is not available for math function or reference waveforms.

The amplitude/div setting is displayed in the status bar at the bottom of the screen.

To adjust the vertical position

Adjusting their vertical position lets you compare waveforms by aligning them above one another or on top of each other.

When an input channel waveform is on:

- Turn the vertical position knob to change the vertical position of the waveform on the screen.

Notice that the ground reference symbol on the left side of the display moves with the waveform.

- Push the vertical position knob to “zero” the ground reference (in other words, move it to the center of the screen).

Notice that, as you adjust the vertical position, a message showing the position of the ground reference relative to the center of the screen is temporarily displayed in the lower left-hand corner of the screen.

To specify channel coupling

- 1 If the channel's menu is not currently displayed, press the channel key ([1], [2], [3], or [4]).
- 2 In the Channel menu, press **Coupling**.
- 3 Continue pressing the **Coupling** softkey or turn the  entry knob to select between:

DC	<p>Passes both DC and AC components of the input waveform to the oscilloscope. See Figure 17.</p> <p>You can quickly measure the DC component of the waveform by simply noting its distance from the ground symbol.</p>
AC	<p>Blocks the DC component of the input waveform and passes the AC component. See Figure 18.</p> <p>This lets you use greater sensitivity (amplitude/div settings) to display the AC component of the waveform.</p>
GND	<p>The waveform is disconnected from the oscilloscope input.</p>

2 Displaying Data

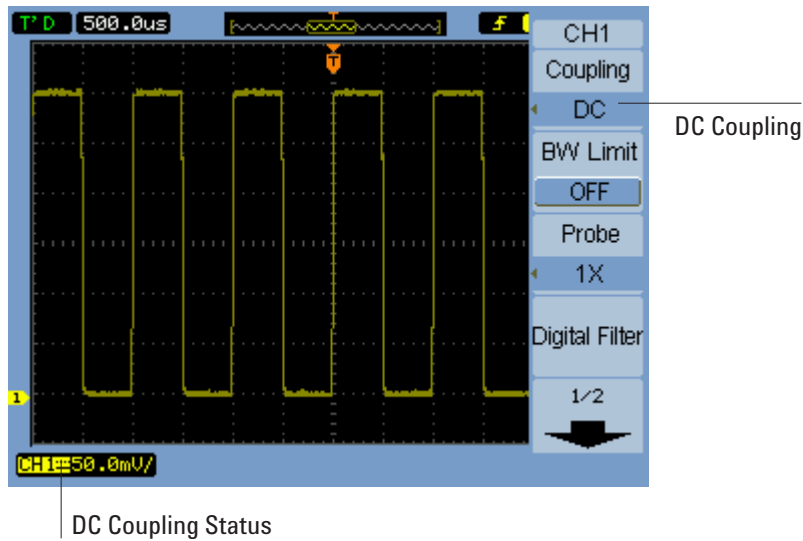

Figure 17 DC Coupling Control

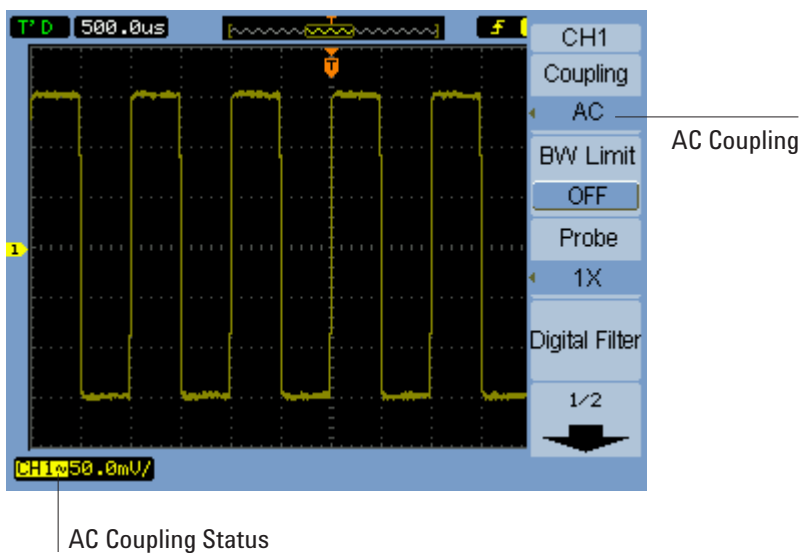

Figure 18 AC Coupling Control

To specify a bandwidth limit

When high frequency components of a waveform are not important to its analysis, the bandwidth limit control can be used to reject frequencies above 20 MHz. See [Figure 20](#) and [Figure 19](#).

- 1 If the channel's menu is not currently displayed, press the channel key ([1], [2], [3], or [4]).
- 2 In the Channel menu, press **BW Limit** to toggle the bandwidth limit setting "ON" and "OFF".

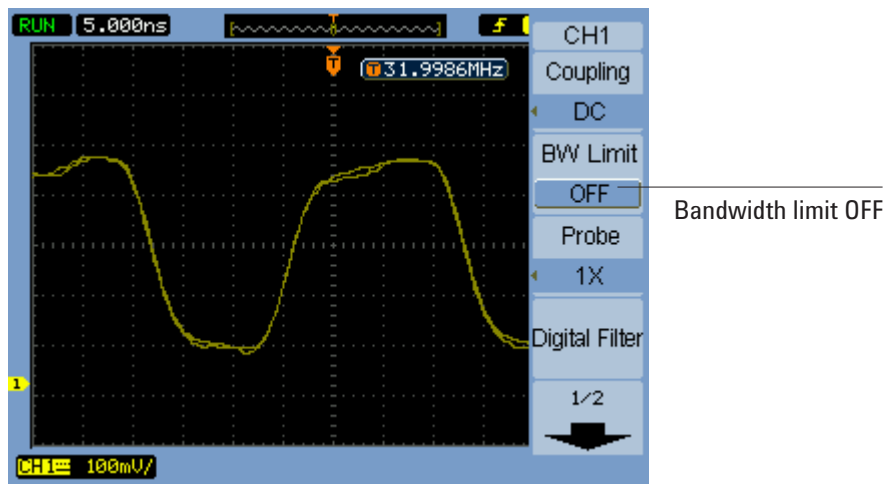

Figure 19 BW Limit Control OFF

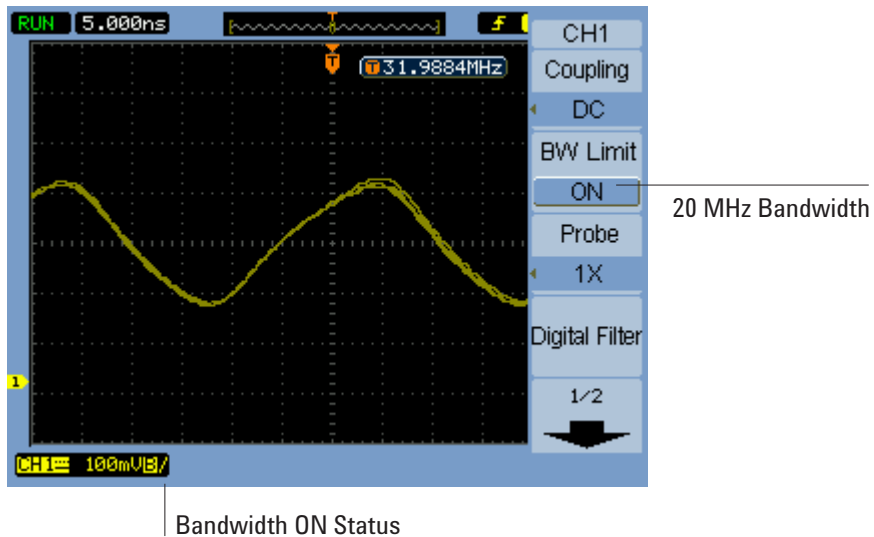

Figure 20 BW Limit Control ON

To specify the probe attenuation

For correct measurements, you must match the oscilloscope’s probe attenuation factor settings with the attenuation factors of the probes being used.

The probe attenuation factor setting changes the vertical scaling of the oscilloscope so that the measurement results reflect the actual voltage levels at the probe tip.

- 1 If the channel’s menu is not currently displayed, press the channel key ([1], [2], [3], or [4]).
- 2 In the Channel menu, press **Probe**.
- 3 Continue pressing the **Probe** softkey or turn the ↻ entry knob to select between:

0.001X For 1:1000 probes.

0.01X For 1:100 probes.

0.1X	For 1:10 probes.
1X	For 1:1 probes.
10X	For 10:1 probes.
100X	For 100:1 probes.
1000X	For 1000:1 probes.

To use a digital filter

You can apply a digital filter to the sampled waveform data.

- 1 If the channel's menu is not currently displayed, press the channel key ([1], [2], [3], or [4]).
- 2 In the Channel menu, press **Digital Filter**.
- 3 In the Filter menu, press **Filter Type**, and continue pressing the **Filter Type** softkey or turn the  entry knob to select between:

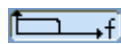

LPF (Low Pass Filter).

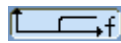

HPF (High Pass Filter).



BPF (Band Pass Filter).

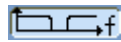

BRF (Band Reject Filter).

- 4 Depending on the type of filter selected, press **Upper Limit** and/or **Lower Limit**, and turn the  entry knob to adjust the limit.

The horizontal scale control sets the maximum value for the upper and lower limits.

Digital filters are not available when:

- The horizontal scale is 20 ns/div or lower.
- The horizontal scale is 50 ms/div or higher.

To change the Volts/Div control sensitivity

When you need to adjust the amplitude/div setting in smaller increments, you can change the sensitivity of the vertical scale control.

- 1 If the channel's menu is not currently displayed, press the channel key ([1], [2], [3], or [4]).
- 2 In the Channel menu, press **Volts/Div** to toggle between:

Coarse	The vertical scale knob changes the amplitude/div setting in a 1-2-5 step sequence from 2 mV/div to 10 V/div (with "1X" probe attenuation).
Fine	Also known as vernier, the vertical scale knob changes the amplitude/div setting in small steps between the normal (coarse scale) settings.

You can also toggle between coarse and fine settings by pushing the vertical scale knob (see ["To adjust the vertical scale"](#) on page 44).

To invert a waveform

You can invert a waveform with respect to the ground level.

- 1 If the channel's menu is not currently displayed, press the channel key ([1], [2], [3], or [4]).
- 2 In the Channel menu, press **Invert** to toggle between "ON" and "OFF".

[Figure 21](#) and [Figure 22](#) show the changes before and after inversion.

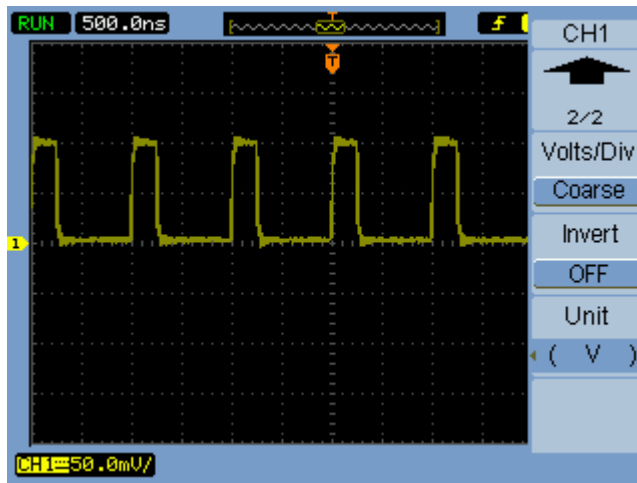

Figure 21 Waveform Before Inversion

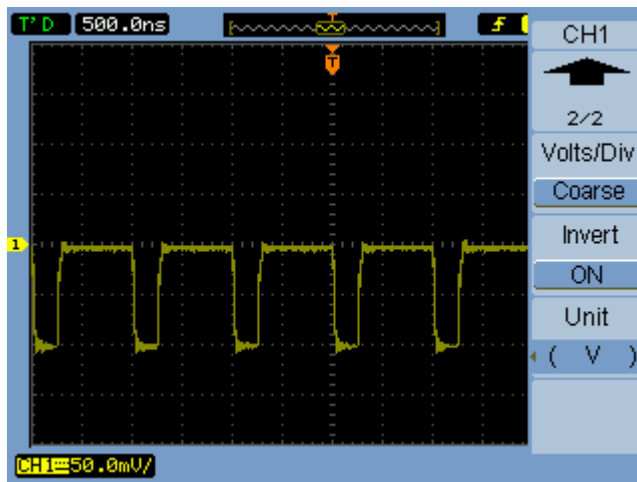



Figure 22 Waveform After Inversion

To specify the channel units

- 1 If the channel's menu is not currently displayed, press the channel key ([1], [2], [3], or [4]).
- 2 In the Channel menu, press **Unit**.
- 3 Continue pressing the **Unit** softkey or turn the  entry knob to select between:

V	Volts, used with voltage probes.
A	Amperes, used with current probes.
W	Watts.
U	Unknown.

Using Math Function Waveforms

The math functions control allows the selection of the math functions:

- Add.
- Subtract.
- Multiply.
- FFT (Fast Fourier Transform).

The mathematical result can be measured using the grid and cursor controls.

The amplitude of the math waveform can be adjusted using a menu item selection in the Math menu and the  entry knob. The adjustment range is in a 1-2-5 step from 0.1% to 1000%.

The math scale setting is shown at the bottom of the display.

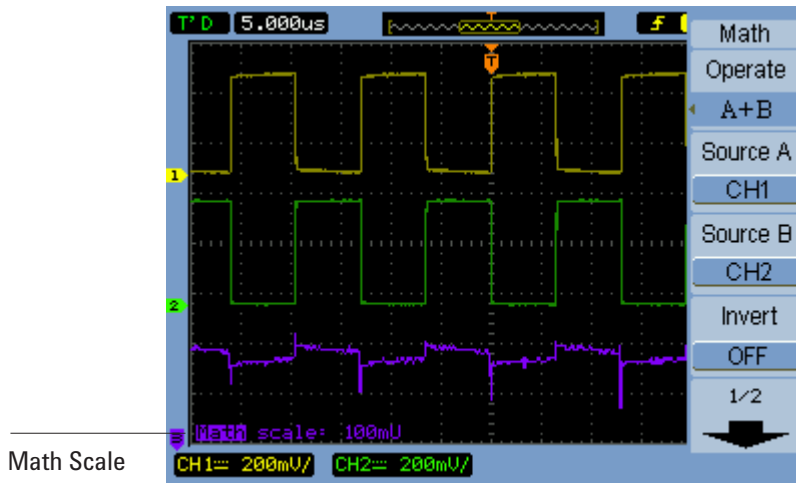



Figure 23 Math Scale Setting Value

To add, subtract, or multiply waveforms

- 1 Press **[Math]**.
- 2 In the Math menu, press **Operate**.
- 3 Continue pressing the **Operate** softkey or turn the  entry knob to select “A + B”, “A - B”, or “A x B”.
- 4 Press **Source A**, and continue pressing the softkey to select the desired input channel.
- 5 Press **Source B**, and continue pressing the softkey to select the desired input channel.
- 6 To invert the result of the addition, subtraction, or multiplication (with respect to the reference level), select **Invert** to toggle between “ON” and “OFF”.

To display the frequency domain using FFT

The FFT math function mathematically converts a time-domain waveform into its frequency components. FFT waveforms are useful for finding the harmonic content and distortion in systems, for characterizing noise in DC power supplies, and for analyzing vibration.

To display a waveform’s FFT:

- 1 Press **[Math]**.
- 2 In the Math menu, press **Operate**.
- 3 Continue pressing the **Operate** softkey or turn the  entry knob to select “FFT”.
- 4 In the FFT menu, press **Source**, and continue pressing the softkey to select the desired input channel.

NOTE

The FFT of a waveform that has a DC component or offset can cause incorrect FFT waveform magnitude values. To minimize the DC component, choose AC Coupling on the source waveform.





To reduce random noise and aliasing components (in repetitive or single-shot waveforms), set the oscilloscope acquisition mode to averaging.

- 5 Press **Window**, and continue pressing the softkey or turn the  entry knob to select the desired window:

There are four FFT windows. Each window has trade-offs between frequency resolution and amplitude accuracy. What you want to measure and your source waveform characteristics help determine which window to use. Use the guidelines in [Table 4](#) to select the best window.

Table 4 FFT Window Characteristics

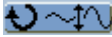
Window	Characteristics	Best for measuring
Rectangle	Best frequency resolution, worst magnitude resolution. This is essentially the same as no window.	Transients or bursts, the waveform levels before and after the event are nearly equal. Equal-amplitude sine waves with fixed frequencies. Broadband random noise with a relatively slow varying spectrum.
Hanning, Hamming	Better frequency, poorer magnitude accuracy than Rectangular. Hamming has slightly better frequency resolution than Hanning.	Sine, periodic, and narrow-band random noise. Transients or bursts where the waveform levels before and after the events are significantly different.
Blackman	Best magnitude, worst frequency resolution.	Single frequency waveforms, to find higher order harmonics.

- 6 Press **Display** to toggle between a “Split” screen display and a “Full Screen” display.
- 7 Press  and turn the  entry knob to adjust the vertical position of the FFT waveform.
- 8 Press  and turn the  entry knob to adjust the vertical scale of the FFT waveform.
- 9 Press **Scale** to toggle between “ V_{RMS} ” and “ dBV_{RMS} ” units.

NOTE

To display FFT waveforms with a large dynamic range, use the dBV_{rms} scale. The dBV_{rms} scale displays component magnitudes using a log scale.

2 Displaying Data

- 10 Use the horizontal position knob to adjust the frequency per division. The frequency scale is displayed on the screen. Use this to display the frequencies associated with the peaks in the FFT waveform.

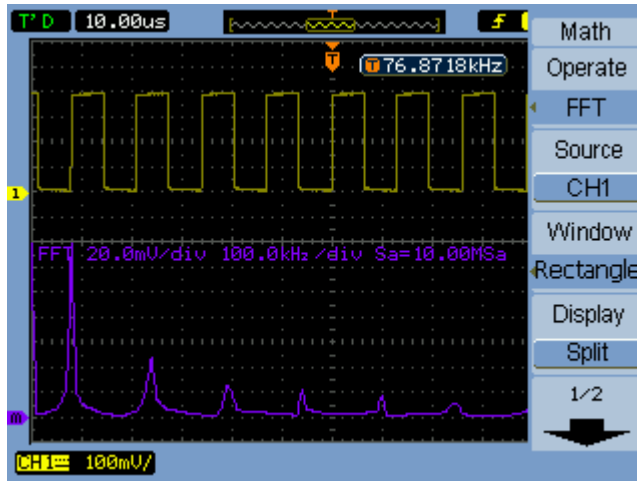

Figure 24 FFT Waveform

NOTE

FFT Resolution

The FFT resolution is the quotient of the sampling rate and the number of FFT points (f_s/N). With a fixed number of FFT points (1024), the lower the sampling rate, the better the resolution.

NOTE

Nyquist Frequency and Aliasing in the Frequency Domain

The Nyquist frequency is the highest frequency that any real-time digitizing oscilloscope can acquire without aliasing. This frequency is half of the sample rate. Frequencies above the Nyquist frequency will be under sampled, which causes aliasing. The Nyquist frequency is also called the folding frequency because aliased frequency components *fold back* from that frequency when viewing the frequency domain.

Using Reference Waveforms

You can save a reference waveform to an internal, nonvolatile memory location and then display it on the oscilloscope along with other captured waveforms.

You can also export/import reference waveforms to/from an external USB drive when it is connected to the front panel USB host port.

Reference waveforms are displayed (that is, turned on/off) just like other waveforms (see [page 43](#)).

NOTE

The reference waveform function is not available in X-Y mode.

To save a reference waveform

- 1 Before saving a waveform as a reference, set the waveform's scale and position as desired.

These settings will become the reference waveform's defaults.

- 2 Press **[REF]**.
- 3 In the REF menu, press **Source**, and continue pressing the softkey or turn the  entry knob to select the waveform you want to save.
- 4 Press **Location** to choose "Internal".
- 5 Press **Save**.

To export or import reference waveforms

To export or import from external storage (when a USB drive is connected to the front panel USB host port):

- 1 Press **[REF]**.
- 2 If exporting a waveform, in the REF menu, press **Source**, and continue pressing the softkey or turn the  entry knob to select the waveform you want to export.

2 Displaying Data

- 3 Press **Location** to choose “External”.
- 4 Press **Save** or **Import**.
- 5 Use the disk manager dialog to navigate to the folder where you want to export the file or to select the file you want to import (see “[To navigate the directory hierarchy](#)” on page 119).
- 6 In the Save or Import menu:
 - To export the waveform, press **New File**, enter the filename (see “[To edit folder/file names](#)” on page 120), and press **Save**.
 - To load the selected waveform (.wfm file), press **Import**.

To return the reference waveform to its default scale

- 1 Press [**REF**].
- 2 In the REF menu, press **Reset**.

The scale and position of the waveform as originally saved are restored.

Changing the Display Settings

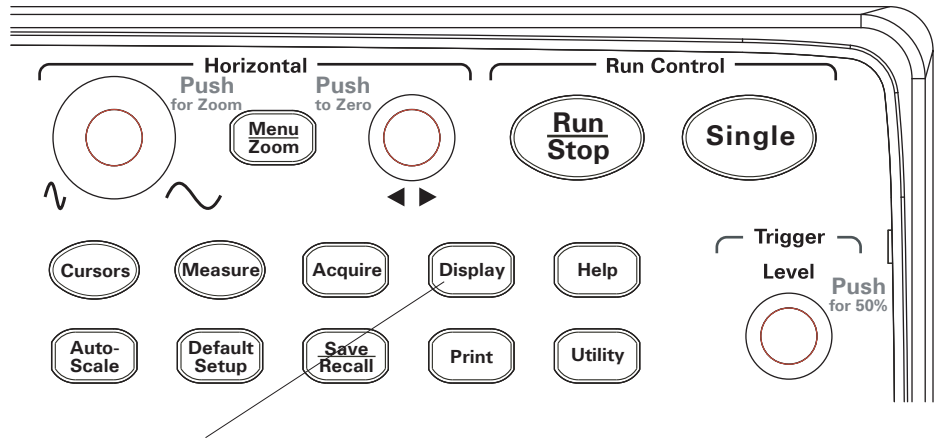

Figure 25 [Display] Key

To display waveforms as vectors or dots

- 1 Press **[Display]**.
- 2 In the Display menu, press **Type** to toggle the waveform display between:

Vectors	The oscilloscope connects the sample points by using digital interpolation. Digital interpolation maintains linearity by using a $\sin(x)/x$ digital filter. The digital interpolation is suitable for real time sampling and is most effective at 20 ns or faster horizontal scale settings.
Dots	The sample points are displayed.

To clear the display

- 1 Press [**Display**].
- 2 In the Display menu, press **Clear**.

To set waveform persistence

- 1 Press [**Display**].
- 2 In the Display menu, press **Persist** to toggle the waveform display between:

Infinite	Sample points remain displayed until the display is cleared or persistence is set to “OFF”.
-----------------	---

OFF

To adjust waveform intensity

- 1 Press [**Display**].
- 2 In the Display menu, press **Intensity** and turn the  entry knob to adjust the waveform intensity.

To display graded waveform intensity

While the oscilloscope is running, waveforms show data from multiple acquisitions. You can cause acquisition data to gradually disappear (similar to analog oscilloscopes).



- 1 Press [**Display**].
- 2 In the Display menu, press **Grading** to toggle the waveform display between:

ON	The most recent data in the waveform is displayed at the highest intensity, and it gradually disappears over time.
OFF	All data in the waveform is displayed at the same intensity.

While waveforms are displayed with graded intensity, you can adjust the normal waveform intensity to bring out the graded detail.

To change the grid

- 1 Press [**Display**].
- 2 In the Display menu, press **Grid**, and continue pressing the softkey or turn the ↻ entry knob to select between:

	Display grid and coordinates on the axes.
	Displays coordinates on the axes.
	Turns off the grid and coordinates.

To change the menu display time

The menu display time is how long menus remain on the screen after a front panel key or softkey has been pressed.

- 1 Press [**Display**].
- 2 In the Display menu, press **Menu Display**, and continue pressing the softkey or turn the  entry knob to select “1 S”, “2 S”, “5 S”, “10 S”, “20 S”, or “Infinite” menu display time.

To adjust the grid brightness

- 1 Press [**Display**].
- 2 In the Display menu, press **GridBright** and turn the  entry knob to adjust the grid brightness.

To invert screen colors

- 1 Press [**Display**].
- 2 In the Display menu, press **Screen** to toggle the screen between “Normal” or “Inverted” colors.

Inverted screen colors are sometimes useful when printing or saving screens.

To select screen persistence

The screen persistence setting specifies what is displayed on the screen when acquisitions are stopped.

To change the screen persistence setting:

- 1 Press **[Display]**.
- 2 In the Display menu, press **Screen Persist** to toggle between:



When acquisitions are stopped, the screen may show data from many acquisitions.



When acquisitions are stopped, the last acquisition is displayed.

2 Displaying Data



3 Capturing Data

Overview of Sampling	66
Choosing the Acquisition Mode	73
Choosing the Acquisition Mode	73
Recording/Playing-back Waveforms	78
Adjusting the Trigger Level	83
Choosing the Trigger Mode	85
Setting Other Trigger Parameters	92
Using the External Trigger Input	96

This chapter describes sampling and acquisition modes and how to set up triggers.



Overview of Sampling

To understand the oscilloscope's sampling and acquisition modes, it is helpful to understand sampling theory, aliasing, oscilloscope bandwidth and sample rate, oscilloscope rise time, oscilloscope bandwidth required, and how memory depth affects sample rate.

Sampling Theory

The Nyquist sampling theorem states that for a limited bandwidth (band-limited) signal with maximum frequency f_{MAX} , the equally spaced sampling frequency f_S must be greater than twice the maximum frequency f_{MAX} , in order to have the signal be uniquely reconstructed without aliasing.

$$f_{MAX} = f_S/2 = \text{Nyquist frequency } (f_N) = \text{folding frequency}$$

Aliasing

Aliasing occurs when signals are under-sampled ($f_S < 2f_{MAX}$). Aliasing is the signal distortion caused by low frequencies falsely reconstructed from an insufficient number of sample points.

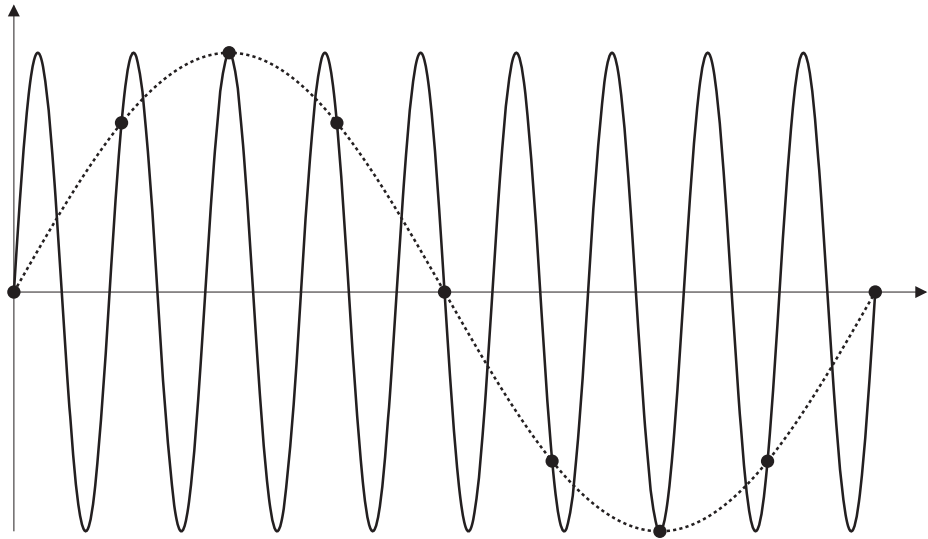

Figure 26 Aliasing

Oscilloscope Bandwidth and Sample Rate

An oscilloscope's bandwidth is typically described as the lowest frequency at which input signal sine waves are attenuated by 3 dB (-30% amplitude error).

At the oscilloscope bandwidth, sampling theory says the required sample rate is $f_S = 2f_{BW}$. However, the theory assumes there are no frequency components above f_{MAX} (f_{BW} in this case) and it requires a system with an ideal brick-wall frequency response.

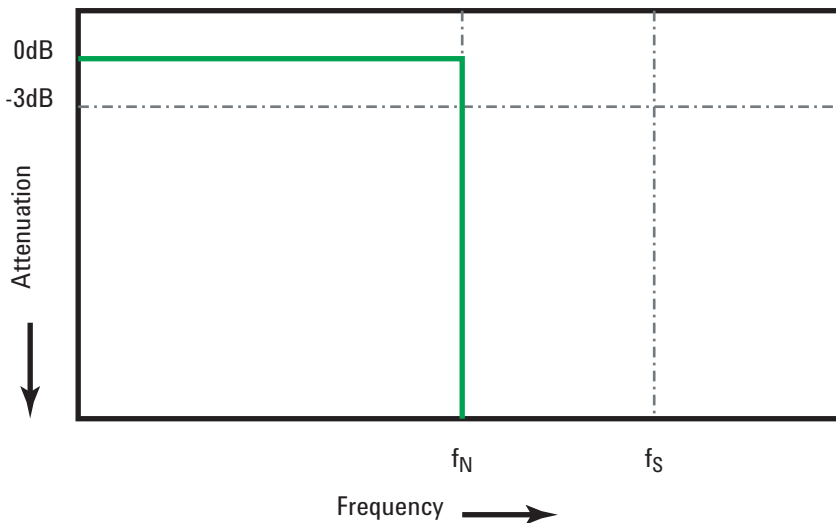
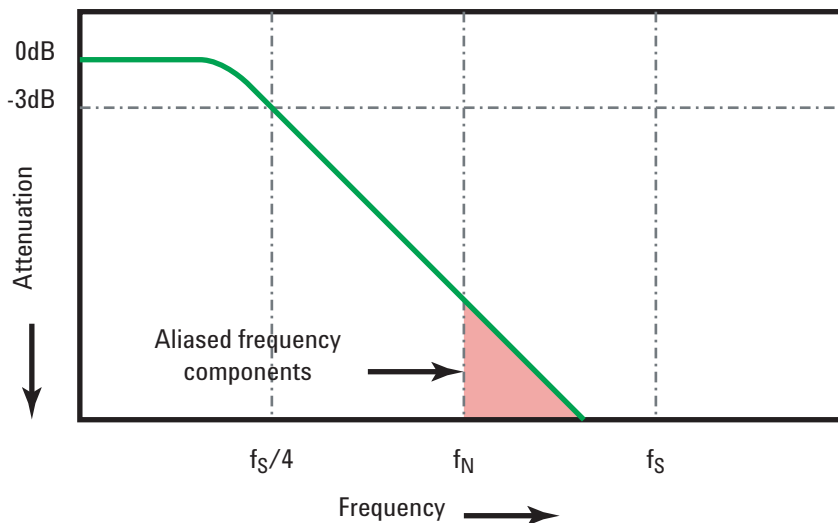

Figure 27 Theoretical Brick-Wall Frequency Response

However, digital signals have frequency components above the fundamental frequency (square waves are made up of sine waves at the fundamental frequency and an infinite number of odd harmonics), and typically, for 1 GHz bandwidths and below, oscilloscopes have a Gaussian frequency response.



Limiting oscilloscope bandwidth (f_{BW}) to 1/4 the sample rate ($f_s/4$) reduces frequency components above the Nyquist frequency (f_N).

Figure 28 Sample Rate and Oscilloscope Bandwidth

So, in practice, an oscilloscope's sample rate should be four or more times its bandwidth: $f_s = 4f_{BW}$. This way, there is less aliasing, and aliased frequency components have a greater amount of attenuation.

See Also *Evaluating Oscilloscope Sample Rates vs. Sampling Fidelity: How to Make the Most Accurate Digital Measurements*, Agilent Application Note 1587 (<http://cp.literature.agilent.com/litweb/pdf/5989-5732EN.pdf>)

Oscilloscope Rise Time

Closely related to an oscilloscope's bandwidth specification is its rise time specification. Oscilloscopes with a Gaussian-type frequency response have an approximate rise time of $0.35/f_{BW}$ based on a 10% to 90% criterion.

An oscilloscope's rise time is not the fastest edge speed that the oscilloscope can accurately measure. It is the fastest edge speed the oscilloscope can possibly produce.

Oscilloscope Bandwidth Required

The oscilloscope bandwidth required to accurately measure a signal is primarily determined by the signal's rise time, not the signal's frequency. You can use these steps to calculate the oscilloscope bandwidth required:

- 1 Determine the fastest edge speeds.

You can usually obtain rise time information from published specifications for devices used in your designs.

- 2 Compute the maximum “practical” frequency component.

From Dr. Howard W. Johnson's book, *High-Speed Digital Design - A Handbook of Black Magic*, all fast edges have an infinite spectrum of frequency components. However, there is an inflection (or “knee”) in the frequency spectrum of fast edges where frequency components higher than f_{knee} are insignificant in determining the shape of the signal.

$$f_{\text{knee}} = 0.5 / \text{signal rise time (based on 10\% - 90\% thresholds)}$$

$$f_{\text{knee}} = 0.4 / \text{signal rise time (based on 20\% - 80\% thresholds)}$$

- 3 Use a multiplication factor for the required accuracy to determine the oscilloscope bandwidth required.

Required accuracy	Oscilloscope bandwidth required
20%	$f_{\text{BW}} = 1.0 \times f_{\text{knee}}$
10%	$f_{\text{BW}} = 1.3 \times f_{\text{knee}}$
3%	$f_{\text{BW}} = 1.9 \times f_{\text{knee}}$

See Also *Choosing an Oscilloscope with the Right Bandwidth for your Application*, Agilent Application Note 1588 (<http://cp.literature.agilent.com/litweb/pdf/5989-5733EN.pdf>)

Real-Time Sampling

The 1000 Series oscilloscopes provide real-time sampling. In other words, waveforms are sampled at uniformly spaced intervals. See [Figure 29](#).

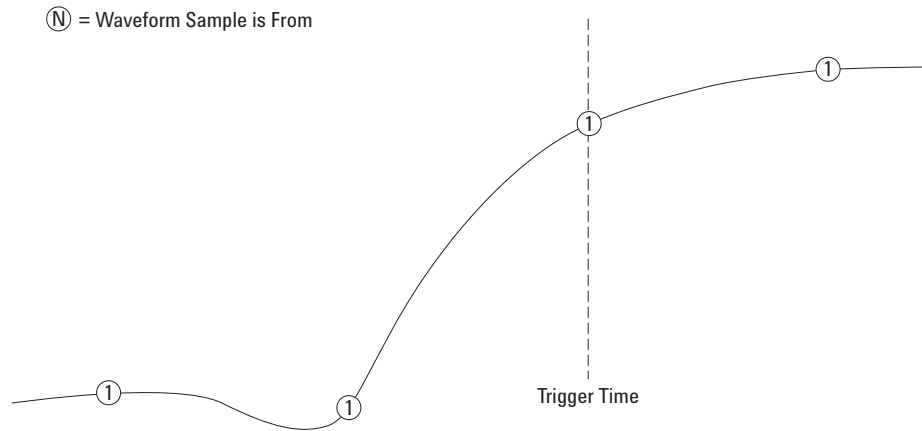

Figure 29 Real-Time Sampling Mode

The 1000 Series oscilloscopes provide real-time sampling rates up to 2 GSa/s.

Memory Depth and Sample Rate

The number of points of oscilloscope memory is fixed (except when divided between channel pairs), and there is a maximum sample rate associated with oscilloscope's analog-to-digital converter; however, the actual sample rate is determined by the time of the acquisition (which is set according to the oscilloscope's horizontal time/div scale).

$$\text{sample rate} = \text{number of samples} / \text{time of acquisition}$$

For example, when storing 10 ns of data in 10,000 points of memory, the actual sample rate is 1 GSa/s.

Likewise, when storing 1 s of data in 10,000 points of memory, the actual sample rate is 10 kSa/s.

The actual sample rate, is displayed in the horizontal Horizontal menu (see [“To view the sample rate”](#) on page 42).

The oscilloscope achieves the actual sample rate by throwing away (decimating) unneeded samples.

Choosing the Acquisition Mode

The oscilloscope can operate in normal, average, or peak detect acquisition modes.

You can choose the oscilloscope's acquisition mode in the Acquire menu (accessed by pressing the **[Acquire]** front panel key).

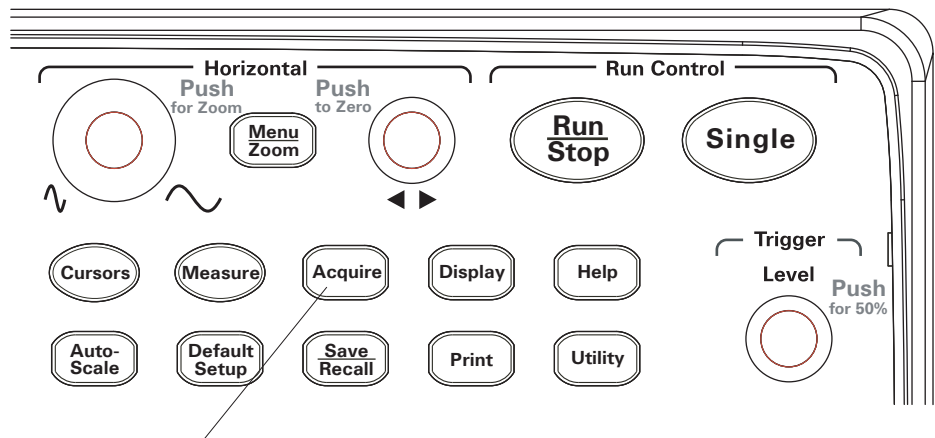



Figure 30 Acquire Key

To select the Normal acquisition mode

In the Normal acquisition mode, acquisitions are made and displayed one after the other.

To select the Normal acquisition mode:

- 1 Press **[Acquire]**.
- 2 In the Acquire menu, press **Acquisition**.
- 3 Continue pressing the **Acquisition** softkey or turn the  entry knob to select "Normal".

To select the Average acquisition mode

In the Average acquisition mode, acquisitions are made, and the running average over the specified number of acquisitions is displayed.

Use the Average acquisition mode to remove random noise from the waveform and to improve measurement accuracy.

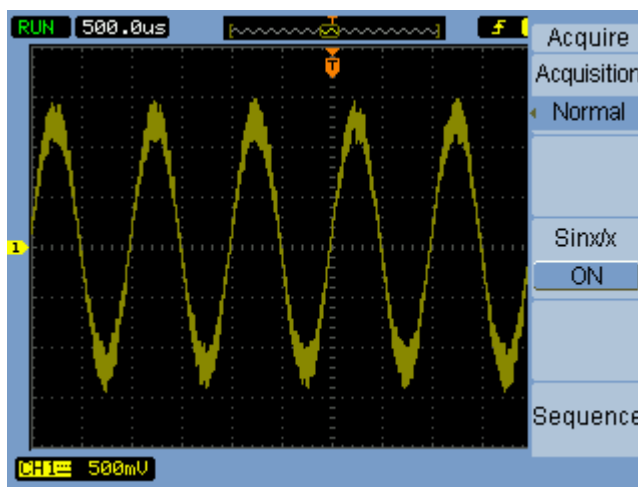

Figure 31 Noisy Waveform Without Averaging

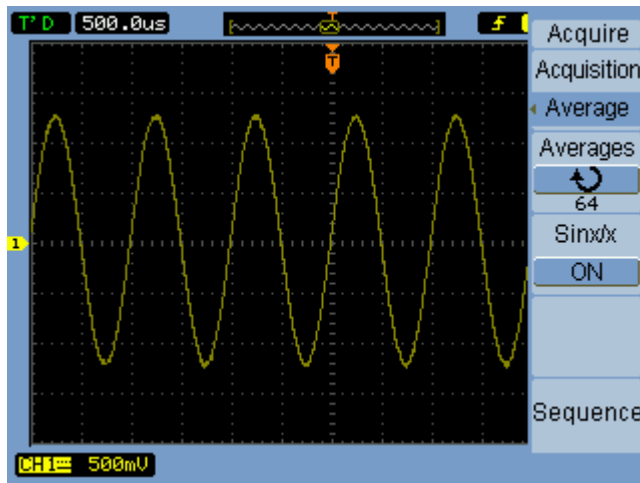



Figure 32 Noisy Waveform With Averaging

The Average acquisition mode decreases the screen refresh rate.

To select the Average acquisition mode:

- 1 Press [**Acquire**].
- 2 In the Acquire menu, press **Acquisition**.
- 3 Continue pressing the **Acquisition** softkey or turn the  entry knob to select “Average”.
- 4 Press **Averages** and turn the  entry knob to select the desired number (2, 4, 8, 16, 32, 64, 128, or 256).

To select the Peak Detect acquisition mode

In Normal or Average acquisition modes, at longer horizontal time/div settings, the oscilloscope’s analog-to-digital converter samples at a rate that yields more samples than can be stored in a limited amount of oscilloscope memory. Consequently, samples are thrown away (decimated), and you can miss narrow excursions on a signal.

3 Capturing Data

However, in the Peak Detect acquisition mode, acquisitions are made at the fastest sample rate, and the minimum and maximum values for the period associated with the actual sample rate are stored. This way, you can capture narrow excursions on a signal at longer horizontal time/div settings.

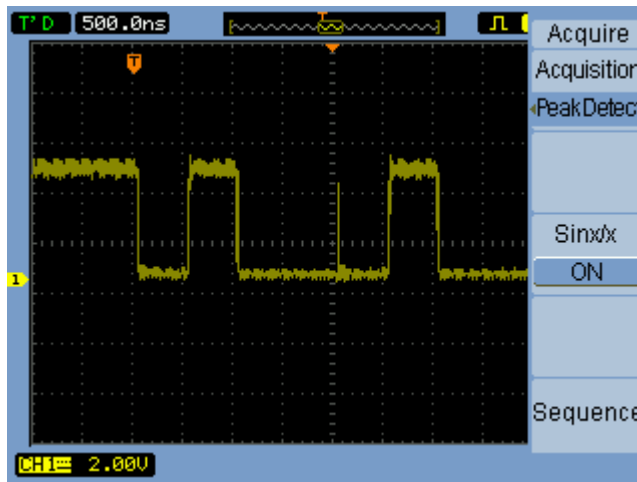

Figure 33 Peak Detect Waveform

Because minimum and maximum values for a sample period are stored, you can use the Peak Detect acquisition mode to avoid waveform aliasing.

To select the Peak Detect acquisition mode:

- 1 Press [**Acquire**].
- 2 In the Acquire menu, press **Acquisition**.
- 3 Continue pressing the **Acquisition** softkey or turn the ↻ entry knob to select “Peak Detect”.

To turn OFF/ON sine(x)/x interpolation

When sample points are displayed as vectors (instead of dots) and sine(x)/x interpolation is on, curved lines are drawn between sample points. When sine(x)/x interpolation is off, straight lines are drawn.

The effects of sine(x)/x interpolation are only noticeable when the horizontal scale is set to 20 ns or faster.

- 1 Press **[Acquire]**.
- 2 In the Acquire menu, press **Sinx/x** to turn sine(x)/x interpolation “OFF” or “ON”.

Recording/Playing-back Waveforms

You can record waveforms from input channels or from the mask test output, with a maximum acquisition depth of 800 frames.

The ability to record mask test output is especially useful for capturing abnormal waveforms over a long period of time.

To record waveforms

To record waveforms:

- 1 Press **[Acquire]**.
- 2 In the Acquire menu, press **Sequence**.
- 3 In the Sequence menu, press **Mode**.
- 4 Continue pressing the **Mode** softkey or turn the  entry knob to select **Record**.

To select the source channel for recording

- 1 In the Sequence menu (**[Acquire]** > **Sequence** > **Mode=Record**), press **Source**.
- 2 Continue pressing the **Source** softkey or turn the  entry knob to select the desired input channel or the mask test output.

To specify the mask test output, see [“To set the mask test output condition”](#) on page 133.

To select the number of frames to record

- 1 In the Sequence menu (**[Acquire]** > **Sequence** > **Mode=Record**), press **End Frame**.
- 2 Turn the  entry knob to select a number from 1 to 800.

To start/stop recording

- 1 In the Sequence menu ([**Acquire**] > **Sequence** > **Mode=Record**), press **Operate** to start or stop recording.



Appears on the menu when not recording; press **Operate** to start recording.



Appears on the menu when recording; press **Operate** to stop recording.

To select the interval between recorded frames

- 1 In the Sequence menu ([**Acquire**] > **Sequence** > **Mode=Record**), press **Interval**.
- 2 Turn the ↻ entry knob to select an interval from 1 ms to 1000 s.

To play-back waveforms

To play-back waveforms:

- 1 Press [**Acquire**].
- 2 In the Acquire menu, press **Sequence**.
- 3 In the Sequence menu, press **Mode**.
- 4 Continue pressing the **Mode** softkey or turn the ↻ entry knob to select “Play back”.

To play-back/stop the recording

- 1 In the Sequence menu ([**Acquire**] > **Sequence** > **Mode=Play back**), press **Operate** to play-back or stop the recording.



Appears on the menu when not playing-back; press **Operate** to start playing-back the recording.



Appears on the menu when playing-back; press **Operate** to stop playing-back.

To select continuous or one-time play-back

- 1 In the Sequence menu ([**Acquire**] > **Sequence** > **Mode=Play back**), press **Play Mode** to toggle between:



Continuous play-back.



One-time play-back.

To select the interval between played-back frames

- 1 In the Sequence menu ([**Acquire**] > **Sequence** > **Mode=Play back**), press **Interval**.
- 2 Turn the ↻ entry knob to select an interval from 1 ms to 20 s.

To select the start frame

- 1 In the Sequence menu ([**Acquire**] > **Sequence** > **Mode=Play back**), press **Start Frame**.
- 2 Turn the ↻ entry knob to select a number from 1 to 800.

To select the current frame

- 1 In the Sequence menu ([**Acquire**] > **Sequence** > **Mode=Play back**), press **Current Frame**.
- 2 Turn the ↻ entry knob to select a number from 1 to 800.

To select the end frame

- 1 In the Sequence menu ([**Acquire**] > **Sequence** > **Mode=Play back**), press **End Frame**.
- 2 Turn the ↻ entry knob to select a number from 1 to 800.

To store recorded waveforms

To store recorded waveforms:

- 1 Press **[Acquire]**.
- 2 In the Acquire menu, press **Sequence**.
- 3 In the Sequence menu, press **Mode**.
- 4 Continue pressing the **Mode** softkey or turn the  entry knob to select “Storage”.

To select the start frame

- 1 In the Sequence menu (**[Acquire]** > **Sequence** > **Mode=Storage**), press **Start Frame**.
- 2 Turn the  entry knob to select a number from 1 to 800.

To select the end frame

- 1 In the Sequence menu (**[Acquire]** > **Sequence** > **Mode=Storage**), press **End Frame**.
- 2 Turn the  entry knob to select a number from 1 to 800.

To select internal/external recording storage location

- 1 In the Sequence menu (**[Acquire]** > **Sequence** > **Mode=Storage**), press **Location** to toggle between Internal and External.

Internal	Recordings are saved and loaded from oscilloscope internal memory.
External	Recordings are saved, loaded, exported, and imported from an external USB drive.

To save a recording

- 1 In the Sequence menu (**[Acquire]** > **Sequence** > **Mode=Storage**), press **Save**.
- 2 If the External location has been selected, use the Disk Manager to name and save the waveform recording file. See [“Using the Disk Manager”](#) on page 118.

To load a recording

- 1 In the Sequence menu (**[Acquire]** > **Sequence** > **Mode=Storage**), press **Load**.
- 2 If the External location has been selected, use the Disk Manager to select and load the waveform recording file. See [“Using the Disk Manager”](#) on page 118.

To import/export recordings

- 1 Because you can only export and import waveform recordings from an external drive, select the External location. See [“To select internal/external recording storage location”](#) on page 81.
- 2 In the Sequence menu (**[Acquire]** > **Sequence** > **Mode=Storage**), press **Imp./Exp..**
- 3 Use the Disk Manager to select the file and import or export the waveform recording. See [“Using the Disk Manager”](#) on page 118.

Adjusting the Trigger Level

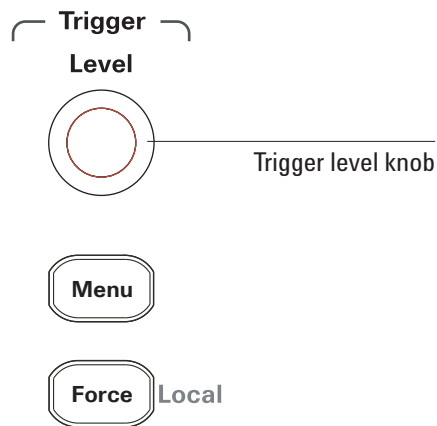

Figure 34 Trigger Controls

To adjust the trigger level

- Turn the trigger **[Level]** knob.
 - Two things happen:
 - The trigger level value is displayed at the lower left-hand corner of the screen.
 - A line is displayed showing the location of the trigger level with respect to the waveform (except when using AC coupling or LF reject coupling modes).
- Push the trigger **[Level]** knob to set the level at 50% of the signal's vertical amplitude.

To force a trigger

To make an acquisition even if no valid trigger has been found:

1 Press **[Force]**.

Forcing a trigger is useful, for example, when you want to display the DC voltage of a level signal.

The **[Force]** key has no effect if the acquisition is already stopped.

When the oscilloscope's front panel is locked by a remote program (shown by a red "Rmt" on the upper-right part of the display), pressing the **[Force]** key returns the front panel to Local control.

Choosing the Trigger Mode

The trigger determines when captured data should be stored and displayed.



When a trigger is set up properly, it can convert unstable displays or blank screens into meaningful waveforms.

When the oscilloscope starts to acquire a waveform, it collects enough data so that it can draw the waveform to the left of the trigger point. The oscilloscope continues to acquire data while waiting for the trigger condition to occur. After it detects a trigger, the oscilloscope continues to acquire enough data so that it can draw the waveform to the right of the trigger point.

The oscilloscope provides these trigger modes:

Edge	Can be used with analog and digital circuits. An edge trigger occurs when the trigger input passes through a specified voltage level with the specified slope.
Pulse	Is used to find pulses with certain widths.
Video	Is used to trigger on fields or lines for standard video waveforms.
Pattern	Is used to trigger on patterns from all input channels.
Alternate	Is used to trigger on non-synchronized signals.

To set up edge triggers

- 1 Press **[Menu]**.
- 2 In the Trigger menu, press **Mode**.
- 3 Continue pressing the **Mode** softkey or turn the  entry knob to select "Edge".
- 4 Then, either push the  entry knob or press **Mode** again.

- 5 Press **Source** and continue pressing the softkey or turn the ↻ entry knob to select the waveform to trigger on:

CH1 - CH4	The oscilloscope input channel.
EXT	The external trigger input.
EXT/5	The (5:1) attenuated external trigger input.
AC Line	The AC power line.

- 6 Press **Slope** and continue pressing the softkey or turn the ↻ entry knob to select the edge to trigger on:



Rising edge.



Falling edge.



Both rising and falling edges.

To set up pulse width triggers

A pulse width trigger occurs when a pulse that matches the pulse definition is found in a waveform.

The width setting can be adjusted from 20 ns to 10 s.

- 1 Press **[Menu]**.
- 2 In the Trigger menu, press **Mode**.
- 3 Continue pressing the **Mode** softkey or turn the ↻ entry knob to select “Pulse”.
- 4 Then, either push the ↻ entry knob or press **Mode** again.

- 5 Press **Source** and continue pressing the softkey or turn the  entry knob to select the waveform to trigger on:

CH1 - CH4	The oscilloscope input channel.
EXT	The external trigger input.
EXT/5	The (5:1) attenuated external trigger input.

- 6 Press **When** and continue pressing the softkey or turn the  entry knob to select the type of pulse to trigger on:



Positive pulse greater than the width setting.

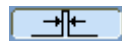

Positive pulse less than the width setting.



Negative pulse greater than the width setting.





Negative pulse less than the width setting.

- 7 Press **Setting** and turn the  entry knob to adjust the width setting.

To set up video triggers

Video triggering is used to trigger on fields or lines of NTSC, PAL, or SECAM standard video waveforms.

When the video trigger mode is selected, the trigger coupling is set to AC.

- 1 Press [**Menu**].
- 2 In the Trigger menu, press **Mode**.
- 3 Continue pressing the **Mode** softkey or turn the  entry knob to select "Video".
- 4 Then, either push the  entry knob or press **Mode** again.

5 Press **Polarity** to toggle between:



Normal polarity – trigger on the negative edge of the sync pulse.



Inverted polarity – trigger on the positive edge of the sync pulse.

NOTE

Normal Polarity Sync triggers always occur on negative-going horizontal sync pulses. If the video waveform has positive-going horizontal sync pulses, use the Inverted Polarity selection.

6 Press **Sync** and continue pressing the softkey or turn the  entry knob to select what to trigger on:

All Lines Trigger on all lines.

Line Num Trigger on a selected line.
If you select “Line Num”, press the following **Line Num** menu item and turn the  entry knob to select the line number.

Odd Field Trigger on an odd field.

Even Field Trigger on an even field.

7 Press **Standard** to toggle between:

NTSC Trigger on an NTSC video waveform.

**PAL/
SECAM** Trigger on a PAL or SECAM video waveform.

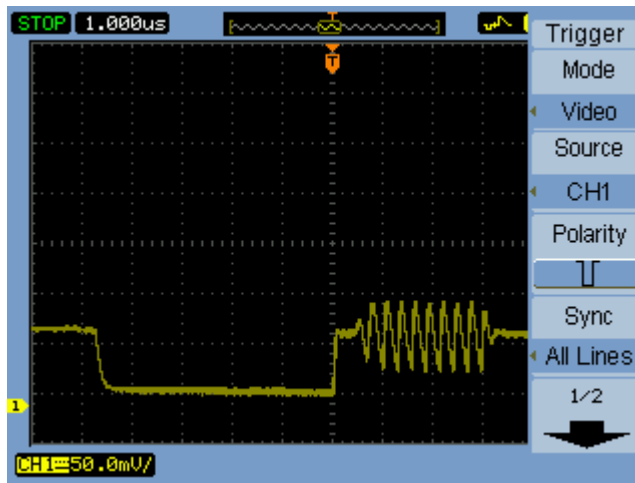

Figure 35 Line Synchronization

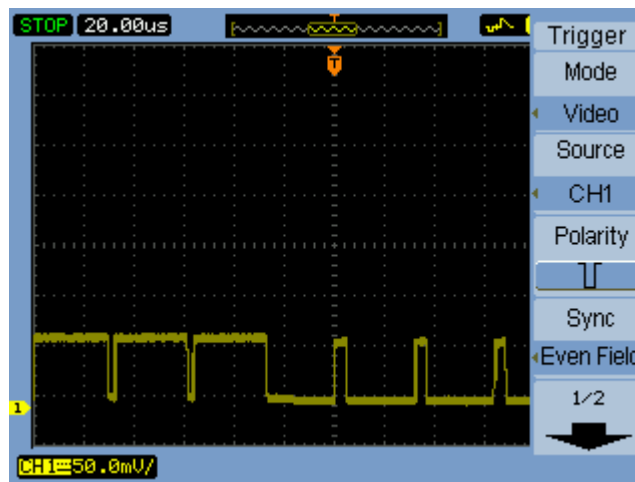







Figure 36 Field Synchronization

To set up pattern triggers

- 1 Press **[Menu]**.
- 2 In the Trigger menu, press **Mode**.
- 3 Continue pressing the **Mode** softkey or turn the  entry knob to select “Pattern”.
- 4 Then, either push the  entry knob or press **Mode** again.
- 5 Press **Channel** and continue pressing the softkey or turn the  entry knob to select the input channel whose value you want to specify:

CH1 - CH4	The oscilloscope input channel.
EXT	The external trigger input.
EXT/5	The (5:1) attenuated external trigger input.

- 6 Press **Code** and continue pressing the softkey or turn the  entry knob to select the value for the selected channel:



H	Logical high value.
L	Logical low value.
X	Don't care value.
	Rising edge.
	Falling edge.

- 7 Repeat steps 5 through 6 to select the desired values for all input channels.

The oscilloscope triggers when all the values in the pattern occur at the same time.

To set up alternate triggers

The Alternate trigger mode splits the display horizontally and lets you trigger on two, non-synchronized signals.

- 1 Press **[Menu]**.
- 2 In the Trigger menu, press **Mode**.
- 3 Continue pressing the **Mode** softkey or turn the  to select “Alternate”.
- 4 Then, either push the  or press **Mode** again.
- 5 Press **Select** to select the channel to set up triggering on, either “CH1” or “CH2”.

At this point, the remaining items in the Trigger menu let you set up independent triggers for the selected channel.

For each source, you can set up edge, pulse width, or video triggering. You can also specify other trigger setup options, except trigger sweep.

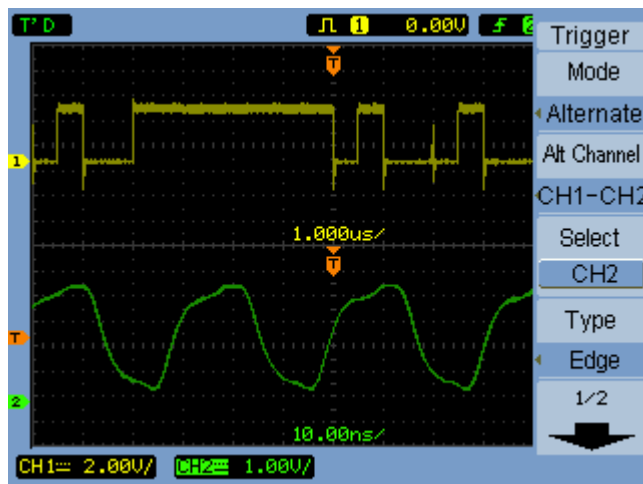



Figure 37 Alternate Triggers

Setting Other Trigger Parameters

These are trigger system parameters that apply in all trigger modes.

To set the trigger sweep

Trigger sweep specifies whether acquisitions occur without a trigger or only with a trigger.

- 1 Press **[Menu]**.
- 2 In the Trigger menu, press **Sweep**.
- 3 Continue pressing the **Sweep** softkey or turn the  entry knob to select one of these trigger sweep settings:

Auto	Acquire waveform even when no trigger occurs.
Normal	Acquire waveform when trigger occurs.

To set the trigger coupling

Trigger coupling is used to filter low frequency signal components or DC offsets from the trigger path when they interfere with achieving stable triggers.

Trigger coupling is similar to channel coupling (see [page 45](#)), but it only affects the triggering system and does not change how the signal is displayed.

To set the trigger coupling:

- 1 Press **[Menu]**.
- 2 In the Trigger menu, press **Set Up**.
- 3 In the Set Up menu, press **Coupling**.

- 4 Continue pressing the the **Coupling** softkey or turn the  entry knob to select one of these trigger coupling settings:

DC	Sets the trigger coupling to DC.
AC	Sets the trigger coupling to AC – use for waveforms greater than 50 Hz.
LF Reject	Sets the trigger coupling to low frequency reject (10 kHz cutoff).

To set the trigger high-frequency reject coupling

Trigger high-frequency reject coupling (100 kHz cutoff) is used to filter high frequency signal components from the trigger path when they interfere with achieving stable triggers.

To set the trigger high-frequency reject coupling:

- 1 Press [**Menu**].
- 2 In the Trigger menu, press **Set Up**.
- 3 In the Set Up menu, press **HF Reject** to toggle between “ON” and “OFF”.

To change the trigger sensitivity

Trigger sensitivity specifies the vertical change that must occur in order for a trigger to be recognized. In the 1000 Series oscilloscopes, you can adjust the trigger sensitivity.

For example, to reduce the influence of noise, you can lower the trigger sensitivity (by increasing the vertical change required to trigger).

To change the trigger sensitivity:

- 1 Press **[Menu]**.
- 2 In the Trigger menu, press **Set Up**.
- 3 In the Set Up menu, press **Sensitivity** and turn the  entry knob to adjust the sensitivity setting.

The trigger sensitivity can be adjusted from 0.1 div to 1 div.

To specify a trigger holdoff

Trigger holdoff can be used to stabilize a waveform. The holdoff time is the oscilloscope's waiting period before starting a new trigger. The oscilloscope will not trigger until the holdoff time has expired.

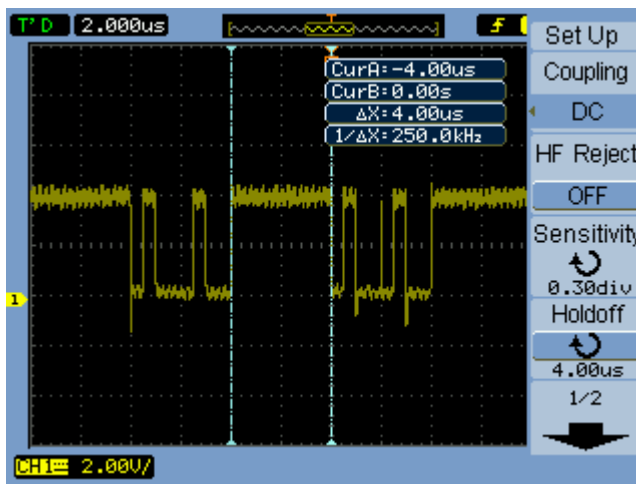



Figure 38 Trigger Holdoff

To specify a trigger holdoff:

- 1 Press [**Menu**].
- 2 In the Trigger menu, press **Set Up**.
- 3 In the Set Up menu, press **Holdoff** and turn the  entry knob to adjust the holdoff setting.

To reset the trigger holdoff

- 1 In the Set Up menu, select the **Holdoff Reset** menu item to return the trigger holdoff setting to the 100 ns minimum value.

Using the External Trigger Input

You can trigger on external inputs by selecting “EXT” or “EXT/5” (5:1 attenuated) as the trigger source in all trigger modes except Alternate.



4 Making Measurements

Displaying Automatic Measurements 98

Voltage Measurements 100

Time Measurements 103

Counter (Frequency) 108

Making Cursor Measurements 109

This chapter shows how to make automatic voltage measurements, automatic time measurements, and cursor measurements.



Displaying Automatic Measurements

You can use the **[Measure]** key to display automatic measurements. The oscilloscope has 22 automatic measurements and a hardware frequency counter (see “[Voltage Measurements](#)” on page 100 and “[Time Measurements](#)” on page 103).

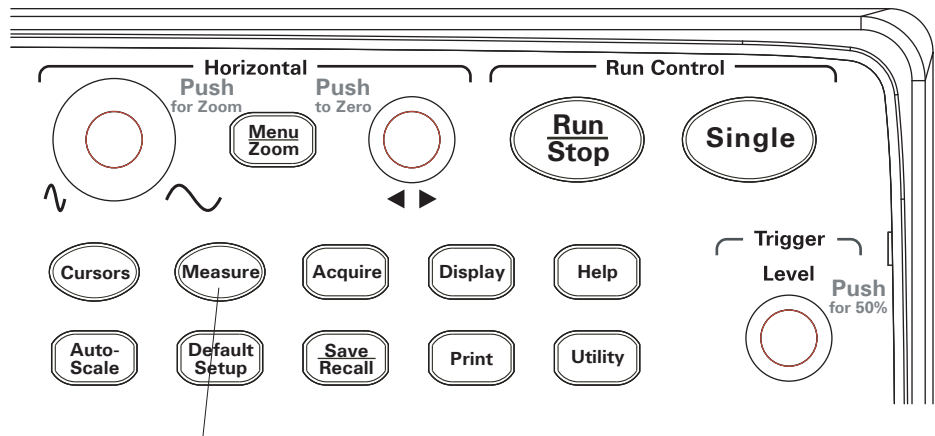

Figure 39 [Measure] Key

To display an automatic measurement

- 1 Press **[Measure]**.
- 2 In the Measure menu, press **Source** to select the input channel on which to make the automatic measurement.
- 3 Press **Voltage** (for voltage measurements) or **Time** (for time measurements) and turn the ↻ entry knob to select the desired measurement.
- 4 Then, either push the ↻ entry knob or press **Voltage** or **Time** again to add the measurement to the bottom of the display.

If the measurement result is displayed as "*****", the measurement cannot be performed with the current oscilloscope settings.

A maximum of three measurements can be displayed at the bottom of the display. When three measurements are displayed and you add a new one, the measurements shift to the left, pushing the first measurement result off screen.

See Also “To display cursors for automatic measurements” on page 112.

To clear automatic measurements from the display

- 1 Press [**Measure**].
- 2 In the Measure menu, press **Clear** to clear all automatic measurements from the display.

To display or hide all automatic measurements

- 1 Press [**Measure**].
- 2 In the Measure menu, press **Display All** to toggle the display of all automatic measurements “ON” or “OFF”.

To select channels for delay/phase measurements

- 1 Press [**Measure**].
- 2 In the Measure menu, press **Delay/Phase**.
- 3 In the Delay/Phase menu, press **DelayA**, **DelayB**, **PhaseA**, or **PhaseB** to select the input channel for the respective measurement.

Voltage Measurements

There are 10 automatic voltage measurements:

- Vmax (Maximum Voltage).
- Vmin (Minimum Voltage).
- Vpp (Peak-to-Peak Voltage).
- Vtop (Top Voltage).
- Vbase (Base Voltage).
- Vamp (Amplitude Voltage = $V_{top} - V_{base}$).
- Vavg (Average Voltage).
- Vrms (Root-Mean-Square Voltage).
- Overshoot.
- Preshoot.

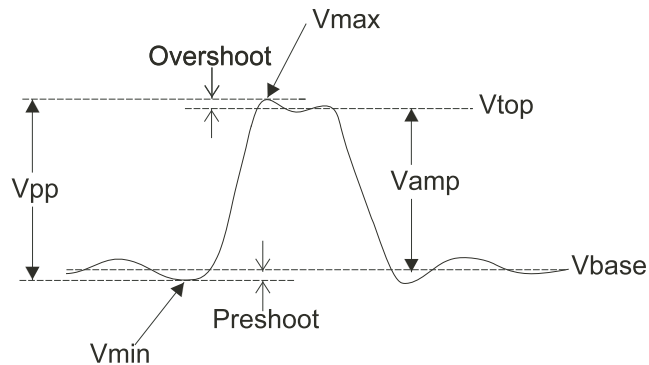

Figure 40 Voltage Measurement Points

Vmax (Maximum Voltage)

The maximum amplitude. The most positive peak voltage measured over the entire waveform. See [Figure 40](#) on page 100.

Vmin (Minimum Voltage)

The minimum amplitude. The most negative peak voltage measured over the entire waveform. See [Figure 40](#) on page 100.

Vpp (Peak-to-Peak Voltage)

Peak-to-peak voltage. See [Figure 40](#) on page 100.

Vtop (Top Voltage)

Voltage of the waveform's flat top, useful for square and pulse waveforms. See [Figure 40](#) on page 100.

Vbase (Base Voltage)

Voltage of the waveform's flat base, useful for square and pulse waveforms. See [Figure 40](#) on page 100.

Vamp (Amplitude Voltage = Vtop - Vbase)

Voltage between Vtop and Vbase of a waveform. See [Figure 40](#) on page 100.

Vavg (Average Voltage)

The arithmetic mean over the entire waveform.

Vrms (Root-Mean-Square Voltage)

The true root-mean-square voltage over the entire waveform.

$$RMS = \sqrt{\frac{\sum_{i=1}^n x_i^2}{n}}$$

Where:

x_i = value at i^{th} point.

n = number of points.

Overshoot

Defined as $(V_{\text{max}} - V_{\text{top}}) / V_{\text{amp}}$, useful for square and pulse waveforms. See [Figure 40](#) on page 100.

Preshoot

Defined as $(V_{\text{min}} - V_{\text{base}}) / V_{\text{amp}}$, useful for square and pulse waveforms. See [Figure 40](#) on page 100.

Time Measurements

There are 12 automatic time measurements plus the hardware frequency counter:

- Period.
- Frequency.
- Rise Time.
- Fall Time.
- + Pulse Width.
- - Pulse Width.
- + Duty Cycle.
- - Duty Cycle.
- Delay A-B, rising edges.
- Delay A-B, falling edges.
- Phase A-B, rising edges.
- Phase A-B, falling edges.

Period

Measures the period of a waveform.

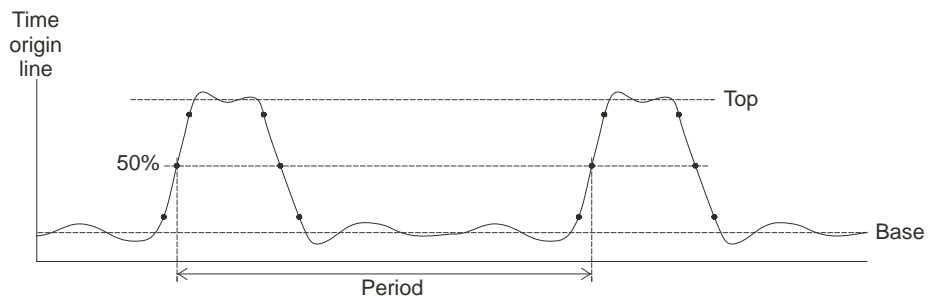

Figure 41 Period and Frequency Measurements

Frequency

Measures the frequency of a waveform. See [Figure 41](#) on page 103.

Rise Time

Measures the rise time of a waveform.

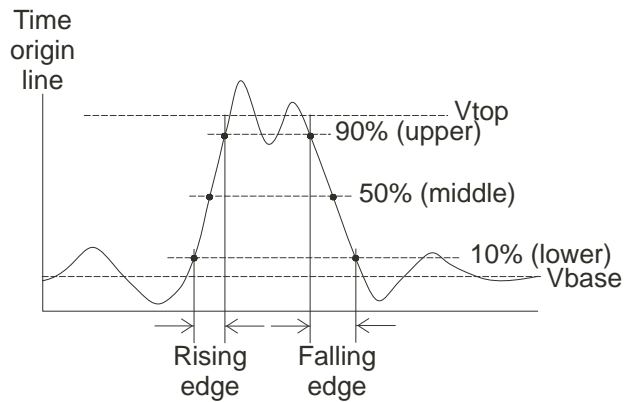

Figure 42 Rise Time and Fall Time Measurements

Fall Time

Measures the fall time of a waveform. See [Figure 42](#) on page 104.

Positive Pulse Width

Measures the positive pulse width of a waveform.

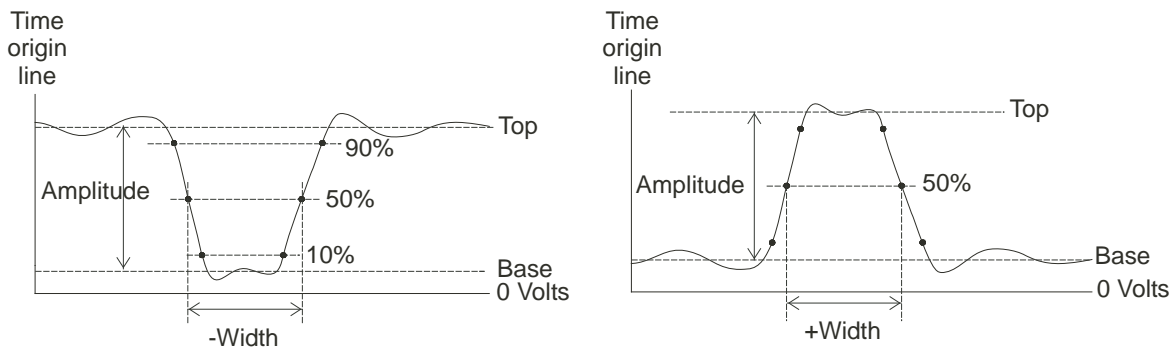

Figure 43 Positive Pulse Width and Negative Pulse Width Measurements

Negative Pulse Width

Measures the negative pulse width of a waveform. See [Figure 43](#) on page 105.

Positive Duty Cycle

Measures the positive duty cycle of a waveform.

Negative Duty Cycle

Measures the negative duty cycle of a waveform.

Delay Between Rising Edges

Measures the delay between two waveforms using the rising edges.

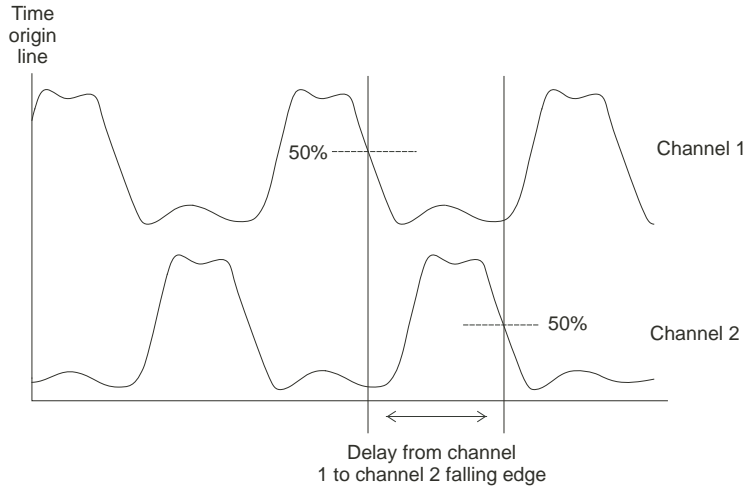

Figure 44 Delay Measurements

Delay Between Falling Edges

Measures the delay between two waveforms using the falling edges. See [Figure 44](#) on page 106.

Phase Between Rising Edges

Measures the phase between two waveforms using the rising edges.

Phase is the calculated phase shift from source 1 to source 2, expressed in degrees. Negative phase shift values indicate that the rising edge of source 1 occurred after the rising edge of source 2.

$$\text{Phase} = \frac{\text{Delay}}{\text{Source 1 Period}} \times 360^\circ$$

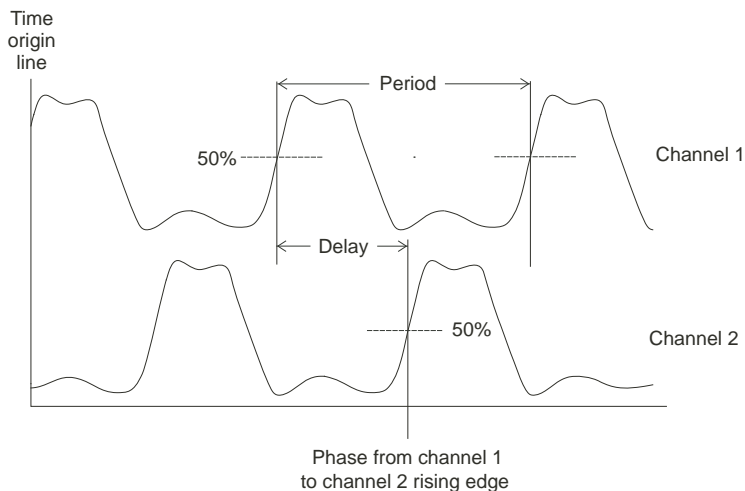

Figure 45 Phase Measurements

Phase Between Falling Edges

Measures the phase between two waveforms using the falling edges. See [Figure 45](#) on page 107.

Counter (Frequency)

The 1000 Series oscilloscopes have an integrated 6-digit hardware frequency counter.

The counter operates on the currently selected trigger source and can measure frequencies from 5 Hz to the bandwidth of the oscilloscope.

The counter uses the trigger comparator to count the number of cycles within a period of time (known as the gate time), so the trigger level must be set correctly.

The frequency counter is not available in the Alternate trigger mode.

To turn the hardware frequency counter on or off:

- 1 Press [**Measure**].
- 2 In the Measure menu, press **Counter** to toggle the frequency counter display “ON” or “OFF”.

Making Cursor Measurements

You can use the **[Cursors]** front panel key to select between these cursor measurement modes:

Manual	Gives you manually adjustable, parallel cursors for measuring time or amplitude between cursors.
Track	Gives you one or two manually adjustable, cross-hair cursors that track the points of a waveform, measuring time and amplitude.
Auto	Gives you automatically adjusted cursors for the most recently displayed voltage or time measurement.
OFF	Cursors are tuned off.

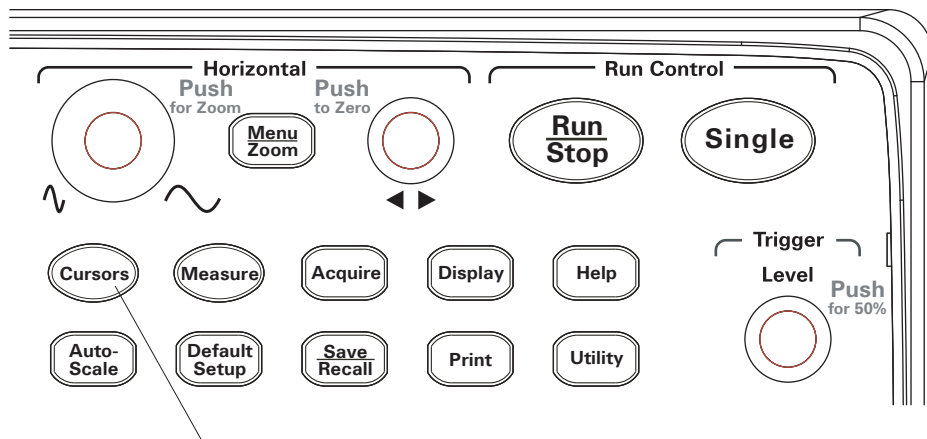







Figure 46 [Cursors] Key

To use manually adjustable cursors

You can set up two parallel, manually adjustable cursors to make amplitude (vertical) or time (horizontal) measurements on a selected waveform.

- 1 Press [**Cursors**].
- 2 In the Cursors menu, press **Mode**.
- 3 Continue pressing the **Mode** softkey or turn the  entry knob to select “Manual”.
- 4 Press **Type** to toggle between:

Time	To use cursors to measure time parameters.
Amplitude	To use cursors to measure amplitude parameters.





- 5 Press **Source**, and continue pressing the softkey or turn the  entry knob to select the channel or math waveform on which to make the measurement.
- 6 To adjust the cursors:
 - Press **CurA** and turn the  entry knob to adjust the “A” cursor.
 - Press **CurB** and turn the  entry knob to adjust the “B” cursor.
 - Press **CurA** and **CurB** and turn the  entry knob to adjust both cursors at the same time.

The cursor values displayed are:

- CurA.
- CurB.
- ΔX or ΔY – difference between CurA and CurB values.
- $1/\Delta X$ – when measuring time parameters, shows the frequency associated with the time period.

To use tracking cross-hair cursors

You can set up one or two manually adjustable, tracking cross-hair cursors to make amplitude (vertical) and time (horizontal) measurements at different points of a selected channel's waveform.

- 1 Press [**Cursors**].
- 2 In the Cursors menu, press **Mode**.
- 3 Continue pressing the **Mode** softkey or turn the  entry knob to select "Track".
- 4 Press **Cursor A**, and continue pressing the softkey or turn the  entry knob to select the channel on which to make the measurement (or "None" to turn off the cursor).
- 5 Press **Cursor B**, and continue pressing the softkey or turn the  entry knob to select the channel on which to make the measurement (or "None" to turn off the cursor).
- 6 To adjust the cursors:
 - Press **CurA** and turn the  entry knob to adjust the "A" cursor.
 - Press **CurB** and turn the  entry knob to adjust the "B" cursor.

The A cursor values displayed are:

- A->X
- A->Y.

The B cursor values displayed are:

- B->X.
- B->Y

If both A and B cursors are used, these values are also displayed:

- ΔX – difference between CurA and CurB time values.
- $1/\Delta X$ – shows the frequency associated with the time value difference.
- ΔY – difference between CurA and CurB amplitude values.

To display cursors for automatic measurements

- 1 Press [**Cursors**].
- 2 In the Cursors menu, press **Mode**.
- 3 Continue pressing the **Mode** softkey or turn the ↻ entry knob to select “Auto”.

In the “Auto” cursors mode:

- Cursors appear for the most recently displayed automatic measurement (see “[To display an automatic measurement](#)” on page 98).
- No cursors are displayed if there are no automatic measurements.

5 Saving, Recalling, and Printing Data

Saving and Recalling Data 114

Using the Disk Manager 118

Printing Screens 123

This chapter describes how to save, recall, and print data.

The oscilloscope has internal, nonvolatile memory locations for saving and recalling waveforms and setups.

The oscilloscope also has rectangular USB host ports on its front and back panel to which you can connect a USB drive (for saving and recalling data).

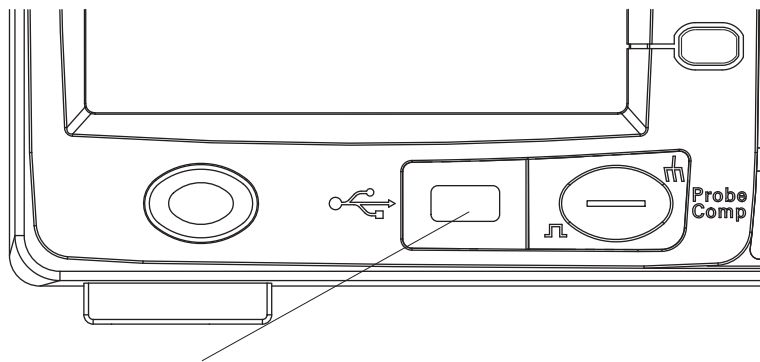

Figure 47 USB Host Port on Front Panel



Saving and Recalling Data

Using the oscilloscope's **[Save/Recall]** key, you can save and recall oscilloscope waveforms and setups, and you can save oscilloscope display screens and data.

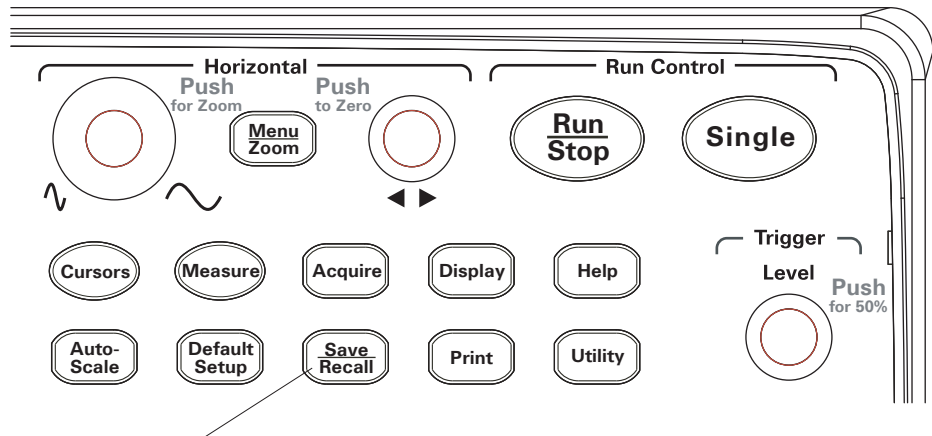

Figure 48 [Save/Recall] Key

When turning off the oscilloscope after saving or recalling data from an external USB drive, allow at least five seconds for the data transfer to complete.

To save and recall waveforms

You can save/recall oscilloscope waveforms and setups to/from 10 internal, nonvolatile memory locations in the oscilloscope.

You can also save/recall waveforms and setups to an external USB drive when it is connected to a rectangular USB host port.

- 1 Press **[Save/Recall]**.
- 2 In the Storage menu, press **Storage**.

- 3 Continue pressing the **Storage** softkey or turn the  entry knob to select “Waveform”.

To save to or recall from internal storage:

- a Press **Internal**.
- b In the Internal menu, press **Location**.
- c Continue pressing the **Location** softkey or turn the  entry knob to select the desired internal storage location.

The “(N)” suffix shows that nothing has been saved to the location.
The “(S)” suffix shows waveforms have been previously saved to the location.

- d Press **Save** or **Recall**.

To save to or recall from external storage (when a USB drive is connected to the front panel USB host port):

- a Press **External**.
- b Use the disk manager dialog to navigate to the folder where you want to save the file or to select the file you want to load (see [“To navigate the directory hierarchy”](#) on page 119).
- c In the External menu:

To save the waveform, press **New File**, enter the filename (see [“To edit folder/file names”](#) on page 120), and press **Save**.

To load the selected waveform (.wfm file), press **Recall**.

To save and recall oscilloscope setups

You can save/recall oscilloscope setups to/from 10 internal, nonvolatile memory locations in the oscilloscope.

You can also save/recall setups to an external USB drive when it is connected to the front panel USB host port.

- 1 Press [**Save/Recall**].
- 2 In the Storage menu, press **Storage**.
- 3 Continue pressing the **Storage** softkey or turn the  entry knob to select “Setups”.

To save to or recall from internal storage:

- a** Press **Internal**.
- b** In the Internal menu, press **Location**.
- c** Continue pressing the **Location** softkey or turn the ↻ entry knob to select the desired internal storage location.
The “(N)” suffix shows that nothing has been saved to the location.
The “(S)” suffix shows waveforms have been previously saved to the location.
- d** Press **Save** or **Recall**.

To save to or recall from external storage (when a USB drive is connected to the front panel USB host port):

- a** Press **External**.
- b** Use the disk manager dialog to navigate to the folder where you want to save the file or to select the file you want to load (see [“To navigate the directory hierarchy”](#) on page 119).
- c** In the External menu:
To save the setup, press **New File**, enter the filename (see [“To edit folder/file names”](#) on page 120), and press **Save**.
To recall the selected setup (.stp file), press **Recall**.

To save screens to BMP or PNG format files

You can save oscilloscope display screens (in BMP or PNG format) to an external USB drive when it is connected to a rectangular USB host port.

- 1** Press [**Save/Recall**].
- 2** In the Storage menu, press **Storage**.
- 3** Continue pressing the **Storage** softkey or turn the ↻ entry knob to select one of:

8-Bitmap	8-bit BMP format.
24-Bitmap	24-bit BMP format.
PNG	Portable Network Graphics format.

- 4 To specify whether oscilloscope parameters be saved along with the screen, press **Para Save** to toggle between on and off.
- 5 Press **External**.
- 6 Use the disk manager dialog to navigate to the folder where you want to save the file (see [“To navigate the directory hierarchy”](#) on page 119).
- 7 In the External menu, press **New File**, enter the filename (see [“To edit folder/file names”](#) on page 120), and press **Save**.

To save data to CSV format files

You can save captured data (in CSV, comma-separated value format) to an external USB drive when it is connected to the front panel USB host port.

- 1 Press [**Save/Recall**].
- 2 In the Storage menu, press [**Storage**].
- 3 Continue pressing the **Storage** softkey or turn the  entry knob to select “CSV”.
- 4 To specify the amount of data to be saved, press **Data Depth** to toggle between “Displayed” and “Maximum”.
- 5 To specify whether oscilloscope parameters be saved along with the data, press **Para Save** to toggle between “ON” and “OFF”.
- 6 Press **External**.
- 7 Use the disk manager dialog to navigate to the folder where you want to save the file (see [“To navigate the directory hierarchy”](#) on page 119).
- 8 In the External menu, press **New File**, enter the filename (see [“To edit folder/file names”](#) on page 120), and press **Save**.

Using the Disk Manager

When a USB drive is connected to the front panel USB host port, you can use the Disk Manager to select and name files and folders.

To access the Disk Mana. menu:

- 1 Press [**Save/Recall**].
- 2 In the Storage menu, press **Disk Mana.**

The Disk Manager screen appears. It looks similar to:

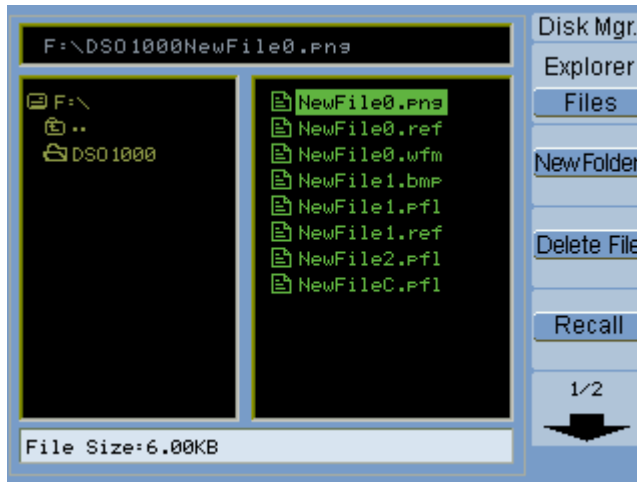

Figure 49 Disk Manager

To switch between files, path, and directory panes



- 1 In the Disk Mana. menu ([**Save/Recall**] > **Disk Mana.**), press **Explorer** to switch between:

Files	Places the cursor in the files pane.
Path	Places the cursor in the path pane.
Directories	Places the cursor in the directories pane.

In each of these panes, the  entry knob is used to select items.

To navigate the directory hierarchy

In the directory pane (see “[To switch between files, path, and directory panes](#)” on page 119):

- Turn the  entry knob to select folders.
- Push the  entry knob to navigate into the selected folder.

To create new folders

- 1 In the Disk Mana. menu ([**Save/Recall**] > **Disk Mana.**), press **New Folder**.
- 2 Use the folder/file naming dialog to enter the folder name. See “[To edit folder/file names](#)” on page 120.
- 3 In the New Folder menu, press **Save**.

To edit folder/file names

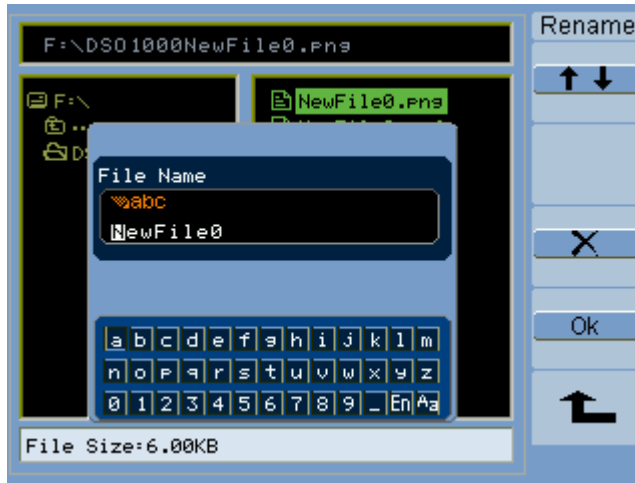





Figure 50 Editing Folder/File Names in Disk Manager

In the folder/file name edit dialog:

- Select the  menu item to move the cursor between fields in the dialog.
- Turn the  entry knob to select:
 - A character in the filename (when the cursor is in the name field).
 - A key (when the cursor is in the keypad field).
- When the cursor is in the keypad field, push the  entry knob to:
 - Choose an alphanumeric character for the name (and move to the next name character).
 - On “Aa”, change from upper to lower case characters on the keypad.
 - On “En”, change from single-byte to multi-byte character entry fields.
- Select the  menu item to delete a character from the name.

To delete folders

In the directory pane (see [“To switch between files, path, and directory panes”](#) on page 119):

- 1 Turn the ↻ entry knob to select folders.
- 2 Press **Del Folder** to delete the selected folder.
- 3 Press **Ok** to confirm the deletion.

To rename folders

In the directory pane (see [“To switch between files, path, and directory panes”](#) on page 119):

- 1 Turn the ↻ entry knob to select the folder.
- 2 Press **Rename**.
- 3 Use the folder/file naming dialog to edit the folder name. See [“To edit folder/file names”](#) on page 120.
- 4 In the Rename menu, press **Ok**.

To delete files

In the files pane (see [“To switch between files, path, and directory panes”](#) on page 119):

- 1 Turn the ↻ entry knob to select the file.
- 2 Press **Delete File** to delete the selected file.
- 3 Press **Ok** to confirm the deletion.

To recall files

In the files pane (see “[To switch between files, path, and directory panes](#)” on page 119):

- 1 Turn the ↶ entry knob to select the file.
- 2 Press **Recall** to load the selected file.

To rename files

In the files pane (see “[To switch between files, path, and directory panes](#)” on page 119):

- 1 Turn the ↶ entry knob to select the file.
- 2 Press **Rename**.
- 3 Use the folder/file naming dialog to edit the file name. See “[To edit folder/file names](#)” on page 120.
- 4 In the Rename menu, press **Ok**.

To display disk information

- 1 In the Disk Mana. menu ([**Save/Recall**] > **Disk Mana.**), press **Disk info**.

Printing Screens

You can print oscilloscope display screens to:

- A PictBridge compliant printer connected to the (square) USB device port on the oscilloscope's back panel.

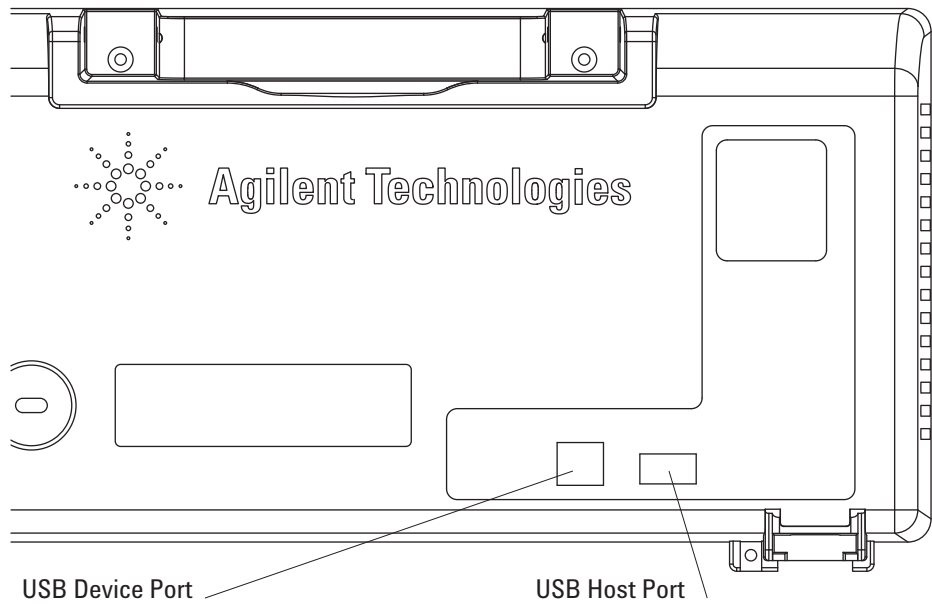

Figure 51 USB Ports on Back Panel

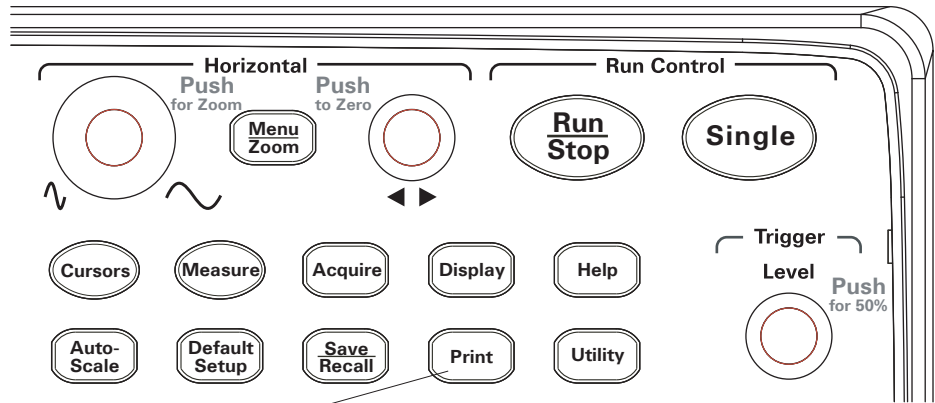

Figure 52 [Print] Key Location

To choose a PictBridge printer

You can print to a PictBridge compliant printer connected to the (square) USB device port on the oscilloscope's back panel.

- 1 Press **[Print]**.
- 2 Press **Paper Size** and turn the ↻ entry knob to select the desired paper size.
- 3 Press **File Type** and turn the ↻ entry knob to select the desired file type.
- 4 Press **Copies** and turn the ↻ entry knob to select the desired number of copies.
- 5 Press **Print Quality** and turn the ↻ entry knob to select the desired print quality.
- 6 Press **Date Print** to turn date printing on the image "ON" or "OFF".

NOTE

The back panel's (square) USB device port is also used for remote programming control of the oscilloscope, so the PictBridge compliant printing and remote programming features cannot be used at the same time.

For more information on remote programming, see the *Agilent 1000 Series Oscilloscopes Programmer's Guide*.

If there are problems when connecting the USB device port to a PictBridge compliant printer or remote computer, see "[To select the USB device port function](#)" on page 137.

To print with inverted screen colors

- 1 Press **[Print]**.
- 2 In the Print menu, press **Inverted** to choose between:

ON	This option changes the black background of display image to white. This can be used to reduce the amount of black ink that takes to print the oscilloscope display images.
OFF	This option prints the display image as shown on the screen.

To choose color or grayscale printing

- 1 Press **[Print]**.
- 2 Press **Palette** to choose between:

Grayscale	When this option is selected, the traces are printed in shades of gray rather than in color.
Color	When this option is selected, the traces are printed in color.

To copy a screen to the printer

- 1 Press [**Print**].
- 2 In the Print menu, press the **Print** softkey.

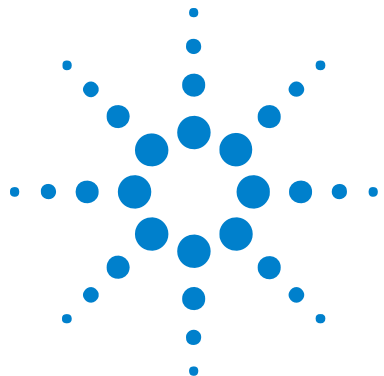

6 Oscilloscope Utility Settings

- Displaying System Information 128
- Turning Sound ON or OFF 128
- Setting and Displaying the Date and Time 129
- Setting the Language (Menu and Help) 130
- Performing Mask Tests 131
- Setting Preferences 136
- Running Self-Calibration 138

This chapter describes oscilloscope settings found in the Utilities menu.

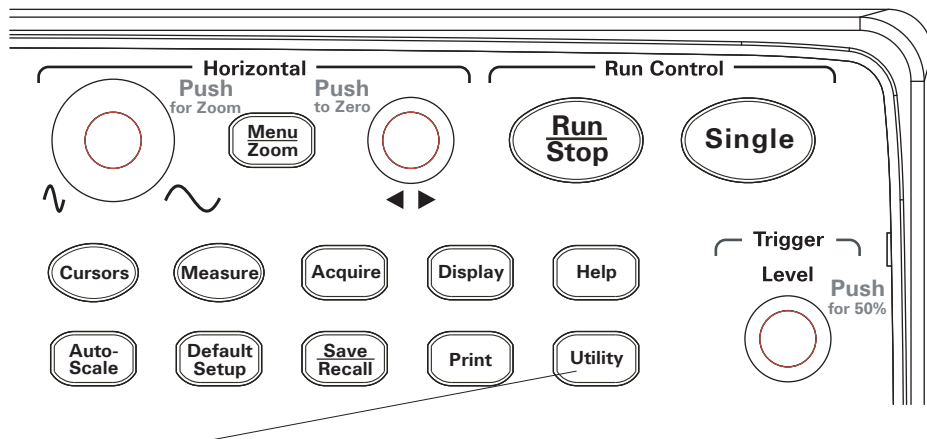

Figure 53 [Utility] Key



Displaying System Information

To display the oscilloscope's system information:

- 1 Press [**Utility**].
- 2 In the Utilities menu, press **System Info**.

The system information contains:

- Model number.
- Serial number.
- Software version.
- Installed module information.

To exit, press **Run/Stop**.

Turning Sound ON or OFF

To turn the oscilloscope's beeper sound on or off:

- 1 Press [**Utility**].
- 2 In the Utilities menu, press **Sound** to toggle between on and off.



Appears on the menu when sound is off; press **Sound** to run the test.





Appears on the menu when sound is on; press **Sound** to stop the test

Setting and Displaying the Date and Time

To set and display the oscilloscope's date and time:

- 1 Press **[Utility]**.
- 2 In the Utilities menu, press **Date/Time**.
- 3 In the Date/time menu, press:

Display	To turn the date/time display “ON” or “OFF”. Dates and times on the display can be useful when recording mask test output waveforms over long periods of time (see “Recording/Playing-back Waveforms” on page 78).
	To move the cursor between the date and time settings.
	To move the cursor between fields within the date or time.
Ok	To apply the date/time setting.

Setting the Language (Menu and Help)

To set the language used in menus and quick help:

- 1 Press [**Utility**].
- 2 In the Utilities menu, press **Language**.
- 3 Continue pressing the **Language** softkey or turn the  entry knob to select the desired language.

You can select from the following languages:

- Simplified Chinese.
- Traditional Chinese.
- Korean.
- Japanese.
- English.
- German.
- French.
- Portuguese.
- Spanish.
- Italian.
- Russian.

If quick help is unavailable in a particular language, English is displayed.

Performing Mask Tests

The mask test function monitors waveform changes by comparing the waveform to a predefined mask.

NOTE

The Mask Test function is not available in the X-Y horizontal timebase mode.

To access the Mask Test menu:

- 1 Press **[Utility]**.
- 2 In the Utilities menu, press **Mask Test**.

To enable/disable mask tests

- 1 In the Mask Test menu (**[Utility]** > **Mask Test**), press **Enable Test** to toggle between OFF and ON.

To select the source channel for mask tests

- 1 In the Mask Test menu (**[Utility]** > **Mask Test**), press **Source**.
- 2 Continue pressing the **Source** softkey or turn the  entry knob to select the desired input channel.

To run/stop a mask test

- 1 In the Mask Test menu ([Utility] > Mask Test), press **Operate** to run or stop the test.



Appears on the menu when the test is stopped; press **Operate** to run the test.



Appears on the menu when the test is running; press **Operate** to stop the test

To turn on/off the mask test message display

- 1 In the Mask Test menu ([Utility] > Mask Test), press **Msg Display** to toggle between OFF and ON.



The message display shows the failed, passed, and total number of waveforms.



Figure 54 Mask Test Display

To set the mask test output condition

- 1 In the Mask Test menu ([Utility] > Mask Test), press **Output**.
- 2 Continue pressing the **Output** softkey to select the desired output condition:

Fail	A mask failure sets the output.
Fail + 	A mask failure sets the output and causes a beep.
Pass	A passing waveform sets the output.
Pass + 	A passing waveform sets the output and causes a beep.

The output condition can be used to stop a running mask test or as a source for the waveform recording function (see “[Recording/Playing-back Waveforms](#)” on page 78).

To stop a mask test on the output condition

To turn on/off stopping the mask test when the output condition occurs:

- 1 In the Mask Test menu ([Utility] > Mask Test), press **Stop On Output** to toggle between OFF and ON.

To set up masks

You can create masks by adding horizontal and vertical margins to a signal. You can save and load masks from internal memory or an external USB drive. And you can export and import masks from an external USB drive.

To access the Mask menu:

- 1 Press [Utility].
- 2 In the Utilities menu, press **Mask Test**.
- 3 In the Mask Test menu, press **MaskSetting**.

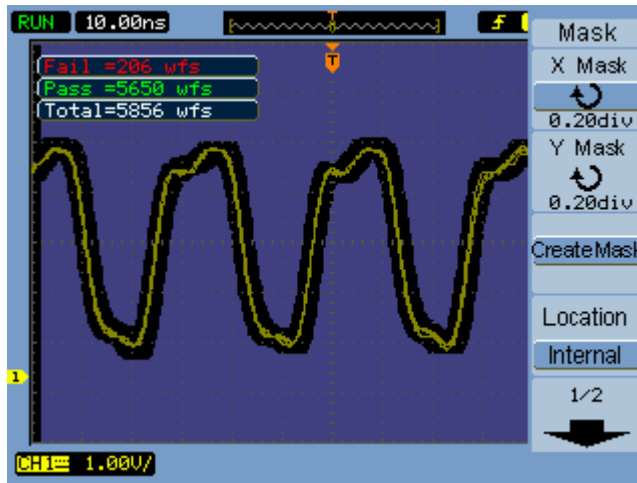



Figure 55 Mask Test Mask Setting

To adjust a mask's horizontal failure margin

- 1 In the Mask menu ([Utility] > **Mask Test** > **MaskSetting**), press **X Mask**.
- 2 Turn the  entry knob to adjust the horizontal failure margin.

The margin can be set from 0.04 div to 4.00 div.

To adjust a mask's vertical failure margin

- 1 In the Mask menu ([Utility] > **Mask Test** > **MaskSetting**), press **Y Mask**.
- 2 Turn the  entry knob to adjust the vertical failure margin.

The margin can be set from 0.04 div to 4.00 div.

To create a mask using the failure margin settings

- 1 In the Mask menu ([Utility] > **Mask Test** > **MaskSetting**), press **Create Mask**.

To select internal/external mask storage location

- 1 In the Mask menu ([Utility] > Mask Test > MaskSetting), press **Location** to toggle between:

Internal	Masks are saved and loaded from oscilloscope internal memory.
External	Masks are saved, loaded, exported, and imported from an external USB drive.

To save a mask

- 1 In the Mask menu ([Utility] > Mask Test > MaskSetting), press **Save**.
- 2 If the External mask storage location has been selected, use the Disk Manager to name and save the mask file. See “Using the Disk Manager” on page 118.

To recall a mask

- 1 In the Mask menu ([Utility] > Mask Test > MaskSetting), press **Recall**.
- 2 If the External mask storage location has been selected, use the Disk Manager to select and load the mask file. See “Using the Disk Manager” on page 118.

To export/import masks

- 1 Because you can only export and import masks from an external drive, select the External mask location. See “To select internal/external mask storage location” on page 135.
- 2 In the Mask menu ([Utility] > Mask Test > MaskSetting), press **Imp./Exp..**
- 3 Use the Disk Manager to select the file and import or export the mask. See “Using the Disk Manager” on page 118.

NOTE

When importing a mask while the **Location** is **Internal** or when importing or recalling a mask while the **Location** is **External**, the mask is imported or recalled to internal memory. To activate the mask, you must set the **Location** to **Internal**, then **Recall** from internal memory.

Setting Preferences

The oscilloscope's Preference menu lets you set screen saver, expand reference, and screen persistence options.

To access the Preference menu:

- 1 Press **[Utility]**.
- 2 In the Utilities menu, press **Preference**.

To set up the screen saver

To set up the screen saver:

- 1 In the Preference menu (**[Utility]** > **Preference**), press **Screen saver**.
- 2 Continue pressing the **Screen saver** softkey or turn the  entry knob to select the desired time or to turn the screen saver off.

Using the screen saver can extend the life of the LCD backlight.

To select the vertical scale reference level

When changing the vertical scale of a signal on the display, the expansion (or contraction) takes place about the selected reference level.

To set the expand reference level:

- 1 In the Preference menu (**[Utility]** > **Preference**), press **Expand Refer.** to toggle between:

Ground	Vertical scale changes take place about the signal ground (ground position remains at same display location).
Center	Vertical scale changes take place about the center of the display.

See Also [“To adjust the vertical scale”](#) on page 44.

To select the USB device port function

The (square) USB device port on the oscilloscope's back panel can be used for:

- Connecting to a PictBridge compliant printer.
- Remote programming control of the oscilloscope.

Normally, the USB device port auto-detects the type of host that is connected. However, if there are auto-detect problems, you can manually choose the type of host that is (or will be) connected.

To select the USB device port function:

- 1 In the Preference menu ([Utility] > Preference), press **USB Device** to toggle between:

Auto Detect	Lets the USB device port auto-detect the type of host that is connected.
Computer	Specifies the that the USB device port will be connected to a computer host.
PictBridge	Specifies the that the USB device port will be connected to a PictBridge compliant printer host.

Running Self-Calibration

The automatic calibration routine adjusts the internal circuitry of the oscilloscope for the best measurement accuracy.

The automatic calibration should be run when the ambient temperature changes by 5 °C or more.

NOTE

Before performing the automatic calibration, let the oscilloscope warm-up at least 30 minutes.

To run the oscilloscope's self-calibration:

- 1 Press **[Utility]**.
- 2 In the Utilities menu, press **Self-Cal**.
- 3 Follow the instructions on the Calibration screen.



Figure 56 Calibration Screen

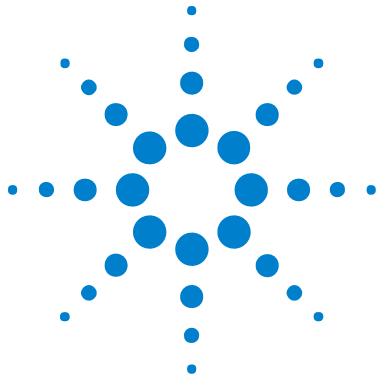

7 Specifications and Characteristics

Environmental Conditions	140
Measurement Category	141
Specifications	142
Characteristics	143

This chapter describes the 1000 Series oscilloscopes' specifications and characteristics.



Environmental Conditions

Overvoltage Category

This product is intended to be powered by MAINS that comply to Overvoltage Category II, which is typical of cord-and-plug connected equipment.

Pollution Degree

The 1000 Series oscilloscope may be operated in environments of Pollution Degree 2 (or Pollution Degree 1).

Pollution Degree Definitions

Pollution Degree 1: No pollution or only dry, non-conductive pollution occurs. The pollution has no influence. Example: A clean room or climate controlled office environment.

Pollution Degree 2. Normally only dry non-conductive pollution occurs. Occasionally a temporary conductivity caused by condensation may occur. Example: General indoor environment.

Pollution Degree 3: Conductive pollution occurs, or dry, non-conductive pollution occurs which becomes conductive due to condensation which is expected. Example: Sheltered outdoor environment.

Measurement Category

The 1000 Series oscilloscope is intended to be used for measurements in Measurement Category I.

Measurement Category Definitions

Measurement category I is for measurements performed on circuits not directly connected to MAINS. Examples are measurements on circuits not derived from MAINS, and specially protected (internal) MAINS derived circuits. In the latter case, transient stresses are variable; for that reason, the transient withstand capability of the equipment is made known to the user.

Measurement category II is for measurements performed on circuits directly connected to the low voltage installation. Examples are measurements on household appliances, portable tools and similar equipment.

Measurement category III is for measurements performed in the building installation. Examples are measurements on distribution boards, circuit-breakers, wiring, including cables, bus-bars, junction boxes, switches, socket-outlets in the fixed installation, and equipment for industrial use and some other equipment, for example, stationary motors with permanent connection to the fixed installation.

Measurement category IV is for measurements performed at the source of the low-voltage installation. Examples are electricity meters and measurements on primary overcurrent protection devices and ripple control units.

Transient Withstand Capability

CAUTION



Maximum input voltage for analog inputs:

- CAT I 300 Vrms, 400 Vpk; transient overvoltage 1.6 kVpk
- with N2862A/N2863A 10:1 probe: CAT I 600 V (DC + peak AC)

Specifications

NOTE

All specifications are warranted. Specifications are valid after a 30-minute warm-up period and ± 5 °C from last calibration temperature.

Table 5 Specifications

Name	Value
Bandwidth (-3 dB) ¹ :	DSO1024A, DSO1022A: 200 MHz DSO1014A, DSO1012A: 100 MHz DSO1004A, DSO1002A: 60 MHz
DC vertical gain accuracy:	2 mV/div to 5 mV/div: $\pm 4.0\%$ full scale 10 mV/div to 5 V/div: $\pm 3.0\%$ full scale
Timebase accuracy:	± 50 ppm from 0 °C to 30 °C ± 50 ppm + 2 ppm per °C from 30 °C to 45 °C + 5 ppm * (years since manufacture)
Trigger sensitivity Ch 1, 2, 3, 4 (DC coupling):	≥ 5 mV/div: 1 div from DC to 10 MHz, 1.5 div from 10 MHz to full bandwidth < 5 mV/div: 1 div from DC to 10 MHz, 1.5 div from 10 MHz to 20 MHz

¹20 MHz when vertical scale is set to < 5 mV (1X probe attenuation).

Characteristics

NOTE

All characteristics are the typical performance values and are not warranted. Characteristics are valid after a 30-minute warm-up period and ± 5 °C from last calibration temperature.

Table 6 Acquisition System Characteristics

Name	Typical Value
Max sample rate:	2 GSa/s half channel ² , 1 GSa/s each channel
Memory depth:	20 kpts half channel ² , 10 kpts each channel
Vertical resolution:	8 bits
Peak detection:	4 ns
Averaging:	Selectable from 2, 4, 8, 16, 32, 64, 128, or 256
Sequence:	Selectable 1 to 800 acquisition frames can be recorded and played back.
Interpolation:	Sin(x)/x

²Half channel is when only one channel of channel pair 1-2 is turned on, or one channel of channel pair 3-4 is turned on.

Table 7 Vertical System Characteristics

Name	Typical Value
Oscilloscope channels:	DS01xx2A: Ch 1 and 2 simultaneous acquisition DS01xx4A: Ch 1, 2, 3, and 4 simultaneous acquisition
Bandwidth (–3dB) ^{1, 3} :	DS0102xA: DC to 200 MHz DS0101xA: DC to 100 MHz DS0100xA: DC to 60 MHz

¹20 MHz when vertical scale is set to < 5 mV (1X probe attenuation).

³Denotes warranted specifications, all others are typical. Specifications are valid after a 30-minute warm-up period and ± 10 ° C from firmware calibration temperature.

Table 7 Vertical System Characteristics (continued)

Name	Typical Value
AC coupled ¹ :	DSO102xA: 5 Hz to 200 MHz DSO101xA: 5 Hz to 100 MHz DSO100xA: 5 Hz to 60 MHz
Calculated rise time (= 0.35/bandwidth in GHz):	DSO102xA: 1.8 ns DSO101xA: 3.5 ns DSO100xA: 5.8 ns
Range:	2 mV/div to 10 V/div (1 M Ω)
Maximum Input: 	Maximum input voltage for analog inputs: <ul style="list-style-type: none"> • CAT I 300 Vrms, 400 Vpk; transient overvoltage 1.6 kVpk • with N2862A/N2863A 10:1 probe: CAT I 600 V (DC + peak AC)
Offset Range:	± 2 V on ranges <500 mV/div; ± 40 V on ranges 500 mV/div to 5 V/div;
Dynamic range:	± 6 div
Input impedance:	1 M Ω \pm 1% 18 \pm 3 pF
Coupling:	AC, DC, ground
BW limit:	20 MHz selectable
DC vertical gain accuracy ³ :	2 mV/div to 5 mV/div: $\pm 4.0\%$ full scale 10 mV/div to 5 V/div: $\pm 3.0\%$ full scale
Channel-to-channel isolation:	DC to max bandwidth >40 dB
Noise peak-to-peak:	3% full scale or 4.5 mV, whichever is greater

¹20 MHz when vertical scale is set to < 5 mV (1X probe attenuation).

³Denotes warranted specifications, all others are typical. Specifications are valid after a 30-minute warm-up period and $\pm 10^\circ$ C from firmware calibration temperature.

Table 8 Horizontal System Characteristics

Name	Typical Value
Range:	DSO102xA: 1 ns/div to 50 s/div DSO101xA: 2 ns/div to 50 s/div DSO100xA: 5 ns/div to 50 s/div
Timebase accuracy ³ :	±50 ppm from 0 °C to 30 °C ±50 ppm + 2 ppm per °C from 30 °C to 45 °C + 5 ppm * (years since manufacture)
Vernier:	1-2-5 increments when off, 1% minor increments between major settings when on.
Modes:	Main, Zoom, Roll, XY
XY:	Bandwidth: Max bandwidth

³Denotes warranted specifications, all others are typical. Specifications are valid after a 30-minute warm-up period and ±10° C from firmware calibration temperature.

Table 9 Trigger System Characteristics

Name	Typical Value
Sources:	DS01xx2A: Ch 1, 2, line, ext, ext/5 DS01xx4A: Ch 1, 2, 3, 4, line, ext, ext/5
Modes (sweep):	Auto, Normal (triggered), single
Holdoff time:	~100 ns to 1.5 s
Selections:	Edge, pulse width, video, pattern, alternate
AutoScale:	Finds and displays all active channels, sets edge trigger mode on highest-numbered channel, sets vertical sensitivity on channels, time base to display ~2.0 periods. Requires minimum voltage > 20 mVpp, 1% duty cycle and minimum frequency > 50 Hz.
Coupling:	AC (~10 Hz), DC, HF reject, and LF reject
Sensitivity Ch 1, 2, 3, 4 (DC coupling) ³ :	≥ 5 mV/div: 1 div from DC to 10 MHz, 1.5 div from 10 MHz to full bandwidth < 5 mV/div: 1 div from DC to 10 MHz, 1.5 div from 10 MHz to 20 MHz

³Denotes warranted specifications, all others are typical. Specifications are valid after a 30-minute warm-up period and ±10° C from firmware calibration temperature.

Table 10 Display System Characteristics

Name	Typical Value
Display:	5.7-inch (145 mm) diagonal color TFT LCD
Display update rate:	Up to 400 waveforms/s
Resolution:	QVGA 320 x 240 dots
Backlight intensity	300 cd/m ²
Persistence:	Off, infinite
Display types:	Dots, vectors
Real-time clock:	Time and date (user adjustable)

Table 11 Measurement Features

Name	Typical Value
Automatic measurements:	Measurements are continuously updated. Cursors track last selected measurement.
Voltage:	Peak-to-peak, maximum, minimum, average, amplitude, top, base, overshoot, preshoot, RMS
Time:	Frequency, period, +width, -width, +duty cycle, -duty cycle, delay rising edge, delay falling edge, phase rising edge, phase falling edge, rise, fall
Display all:	Mode to display all single-channel automatic measurements simultaneously on the display.
Counter:	Built-in 6-digit frequency counter on any channel. Counts up to the oscilloscope's bandwidth.
Cursors:	Manual, track waveform, or automatic measurement selections. Manual and track waveform selections provide readout of Horizontal (X, ΔX , $1/\Delta X$) and Vertical (Y, ΔY).
Waveform math:	One function displayed selected from A+B, A-B, AxB, and FFT. Source selection for A and B can be any combination of oscilloscope channels 1 or 2 (or 3 or 4 on DS01xx4A only).

Table 12 FFT Measurement Features

Name	Typical Value
Points:	Fixed at 1024 points
Source of FFT:	Oscilloscope channels 1 or 2 (or 3 or 4 on DS01xx4A only)
Window:	Rectangular, blackman, hanning, hamming
Amplitude:	Display in dBVrms and Vrms

Table 13 Storage

Name	Typical Value
Save/Recall internal:	10 setups and 10 waveforms can be saved and recalled using internal non-volatile memory locations. 1 reference waveform can be saved and recalled using an internal volatile memory location for visual comparisons.
Save/Recall external USB flash drive:	USB 2.0 compliant host ports on front and rear panel compatible with full-speed USB flash drives. <ul style="list-style-type: none"> • Setups: STP saved and recalled. • Waveforms: WFM saved and recalled, CSV saved. • Reference waveforms: REF saved and recalled for visual comparisons. • Images: 8-bit BMP, 24-bit BMP, PNG saved.
USB flash drive compatibility	Most FAT formatted <2 GB or FAT32 formatted <32 GB flash drives.

Table 14 I/O

Name	Typical Value
Standard ports:	1 USB device, two USB host ports
Max transfer rate:	USB 2.0 full-speed up to 12 Mb/sec
Printer compatibility:	PictBridge compatible printer

Table 15 General Characteristics

Name	Typical Value
Physical size:	32.46 cm wide x 15.78 cm high x 12.92 cm deep
Weight, net:	DS01xx2A: 2.93 kg (6.46 lbs) DS01xx4A: 3.03 kg (6.68 lbs)
Weight, shipping:	DS01xx2A: approximately 4.75 kg (10.47 lbs) DS01xx4A: approximately 4.87 kg (10.74 lbs)
Probe comp output:	Frequency ~1 kHz, Amplitude ~3 V
Kensington lock:	Connection on rear panel for security
Security loop	Thread a security cable through the built-in security loop on the rear panel.

Table 16 Power Requirements

Name	Typical Value
Line rating:	~Line 60 W max 100-120 V/50/60/400 Hz, $\pm 10\%$ 100-240 V/50/60 Hz, $\pm 10\%$

Table 17 Environmental Characteristics

Name	Typical Value
Ambient temperature:	Operating 0 °C to +40 °C Non-operating –20 °C to +60 °C
Humidity:	Operating 90% RH (non-condensing) at +40 °C for 24 hr Non-operating 60% RH (non-condensing) at +60 °C for 24 hr
Altitude:	Operating to 4,400 m (15,000 ft) Non-operating to 15,000 m (49,213 ft)
Vibration:	Agilent class GP and MIL-PRF-28800F; Class 3 random
Shock:	Agilent class GP and MIL-PRF-28800F; (operating 30 g, 1/2 sine, 11-ms duration, 3 shocks/axis along major axis. Total of 18 shocks)
Pollution degree 2:	Normally only dry non-conductive pollution occurs. Occasionally a temporary conductivity caused by condensation must be expected.
Indoor use:	Rated for indoor use only.

Table 18 Other

Name	Typical Value
Measurement categories:	CAT I: Mains isolated

WARNING

Use this instrument only for measurements within its specified measurement categories.

The N2739A rack mount kit is available for placing a 1000 Series oscilloscope into Electronic Industries Association (EIA) standard 19-inch (487-mm) rack cabinets. Installation instructions are included in the kit.

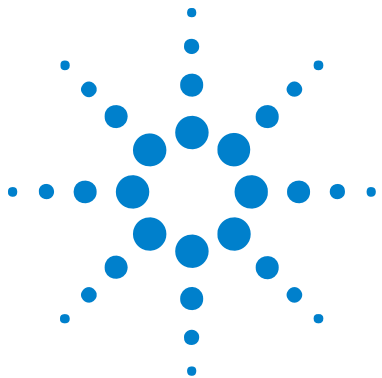

A Safety Notices

Warnings 151

Safety Symbols 152

This apparatus has been designed and tested in accordance with IEC Publication 1010, Safety Requirements for Measuring Apparatus, and has been supplied in a safe condition. This is a Safety Class I instrument (provided with terminal for protective earthing). Before applying power, verify that the correct safety precautions are taken (see the following warnings). In addition, note the external markings on the instrument that are described under "Safety Symbols."

Warnings

- Before turning on the instrument, you must connect the protective earth terminal of the instrument to the protective conductor of the (mains) power cord. The mains plug shall only be inserted in a socket outlet provided with a protective earth contact. You must not negate the protective action by using an extension cord (power cable) without a protective conductor (grounding). Grounding one conductor of a two-conductor outlet is not sufficient protection.
- Only fuses with the required rated current, voltage, and specified type (normal blow, time delay, etc.) should be used. Do not use repaired fuses or short-circuited fuse holders. To do so could cause a shock or fire hazard.
- If you energize this instrument by an auto transformer (for voltage reduction or mains isolation), the common terminal must be connected to the earth terminal of the power source.



A Safety Notices

- Whenever it is likely that the ground protection is impaired, you must make the instrument inoperative and secure it against any unintended operation.
- Service instructions are for trained service personnel. To avoid dangerous electric shock, do not perform any service unless qualified to do so. Do not attempt internal service or adjustment unless another person, capable of rendering first aid and resuscitation, is present.
- Do not install substitute parts or perform any unauthorized modification to the instrument.
- Capacitors inside the instrument may retain a charge even if the instrument is disconnected from its source of supply.
- Do not operate the instrument in the presence of flammable gasses or fumes. Operation of any electrical instrument in such an environment constitutes a definite safety hazard.
- Do not use the instrument in a manner not specified by the manufacturer.

Safety Symbols



Instruction manual symbol: the product is marked with this symbol when it is necessary for you to refer to the instruction manual in order to protect against damage to the product.



Hazardous voltage symbol.



Earth terminal symbol: Used to indicate a circuit common connected to grounded chassis.

Index

Numerics

50% trigger level, 83

A

AC channel coupling, 45
AC coupling, 54
AC trigger coupling, 87, 93
accuracy, measurement, 74
acquisition mode, 73
actual sample rate, 72
add math function, 53
add waveforms, 54
aliasing, 56, 66, 76
alternate trigger, 85, 91
Alternate trigger mode, 108
ampere units, 52
amplitude/div setting, 44
at a glance, 3
attenuation, probe, 48
Auto cursor measurements, 109
auto-detect, USB device port setting, 137
automatic calibration, 138
automatic measurements, 98
automatic measurements, clear, 99
automatic measurements, cursors for, 112
automatic measurements, display or hide, 98, 99
automatic time measurements, 103
automatic voltage measurements, 100
Auto-Scale key, 22
Average acquisition mode, 54, 74, 75

B

backlight, LCD, 136
band pass filter, 49

band reject filter, 49
bandwidth limit, 47
bandwidth required, oscilloscope, 70
bandwidth, oscilloscope, 67
beeper sound, 128
Blackman FFT window, 55
brick-wall frequency response, 67
brightness, grid, 62
built-in help, 3, 32

C

calibration, 138
calibration temperature, 142
center of screen reference, 44, 136
channel coupling, 38, 45
channel pairs, 72
channel units, 52
characteristics, 143
clear automatic measurements, 99
clear the display, 60
coarse adjustment, 50
color printing, 125
colors (screen), invert, 62
comma-separated value files, 117
compensate probes, 24
computer host, USB device port setting, 137
coordinates, grid, 61
counter, frequency, 3
counter, hardware frequency, 108
coupling, trigger, 92
cross-hair cursors, 111
CSV format files, save data to, 117
cursor measurements, 3, 42, 109
cursors for automatic measurements, 112
Cursors key, 109

D

dBVrms scale, 55
DC channel coupling, 45
DC trigger coupling, 93
DC voltage of a level signal, 84
decimated samples, 72, 75
default scale, reference waveform, 58
Default Setup key, 20
Delay Between Falling Edges measurement, 106
Delay Between Rising Edges measurement, 106
delay/phase measurements, selecting channels, 99
delayed sweep time base, 39
digital filter, 3, 49
disk information, displaying, 122
Disk Manager, 118
display all automatic measurements, 99
display, clear, 60
distortion, 54
dots waveform type, 59
dynamic range, 55

E

edge speeds, 70
edge trigger, 85
English language, 130
environmental conditions, 140
Expand Reference preference setting, 44
EXT/5, 96
external trigger input, 96

F

factory default, 20

Index

Fall Time measurement, 104
FFT (Fast Fourier Transform) math function, 53, 54
FFT resolution, 56
FFT windows, 55
field synchronization, 89, 91
file names, editing, 120
files, deleting, 121
files, loading, 122
files, renaming, 122
filter, digital, 49
fine scale adjustment, 44, 50
folder names, editing, 120
folders, creating new, 119
folders, deleting, 121
folders, renaming, 121
folding frequency, 66
force a trigger, 84
French language, 130
frequency counter, hardware, 3, 108
frequency domain, 54
Frequency measurement, 104
frequency scale, 56
frequency, Nyquist, 66
front panel control, 26
functions, math, 53

G

gate time, frequency counter, 108
Gaussian frequency response, 68
German language, 130
GND channel coupling, 45
graded waveform intensity, 61
grayscale printing, 125
grid brightness, 62
grid, changing, 61
ground reference, 44
ground reference level for vertical scaling, 136
ground reference symbol, 44

H

Hanning FFT window, 55
hardware frequency counter, 3, 103, 108
harmonic content, 54
Help key, 32
hide all automatic measurements, 99
high frequency probe compensation, 25
high pass filter, 49
high-frequency reject coupling, trigger, 93
holdoff, trigger, 95
horizontal controls, 36
horizontal failure margin (mask), 134
horizontal position knob, 36, 38, 39, 42
horizontal scale, 37, 77
horizontal scale controls indicators, 37
horizontal scale knob, 36, 38
horizontal time base, 40
horizontal time/div, 75

I

infinite persistence, 60
input voltage, 21
installed module information, 128
intensity, waveform, 60
internal memory locations, 113
internal storage, 3
invert a waveform, 50
invert screen colors, 62
Italian language, 130

J

Japanese language, 130

K

Korean language, 130

L

language, setting the, 130
LCD backlight, 136
LCD display, 3

LF reject trigger coupling, 93
line synchronization, 89
loading data, 114
Local function of [FORCE] key, 84
log scale, 55
low frequency probe compensation, 24
low pass filter, 49

M

Manual cursor measurements, 109
manually adjustable cursors, 110
mask test, 42, 131
mask, creating, 134
mask, loading, 135
mask, saving, 135
masks, exporting/importing, 135
masks, setting up, 133
math function waveforms, 3, 42, 53
math scale setting, 53
maximum sample rate, 72
measurement accuracy, 74
measurement category, 141
measurements, cursor, 109
memory, 3
memory depth and sample rate, 72
menu display time, 62
Menu On/Off button, 20, 22, 29
Menu/Zoom key, 36, 39
menus, 28, 130
model number, 128
module information, 128
multiply math function, 53
multiply waveforms, 54

N

N2862A passive probe, 18
N2863A passive probe, 18
Negative Duty Cycle measurement, 105
Negative Pulse Width measurement, 105
noise in DC power supplies, characterizing, 54
non-synchronized signals, 91

nonvolatile memory locations, 113
 Normal acquisition mode, 73
 normal adjustment, 44
 NTSC standard, 87, 88
 Nyquist frequency, 56
 Nyquist sampling theory, 66

O

oscilloscope bandwidth, 67
 oscilloscope bandwidth required, 70
 oscilloscope display, 30
 oscilloscope rise time, 69
 oscilloscope sample rate, 69
 oscilloscope setups, saving and loading, 115
 overshoot measurement, 102
 overvoltage category, 140

P

package contents, 18
 PAL standard, 87, 88
 parallel cursors, 110
 passive probes, 18
 pattern trigger, 85, 90
 Peak Detect acquisition mode, 75
 Period measurement, 103
 persistence, screen, 63
 persistence, waveform, 60
 Phase Between Falling Edges measurement, 107
 Phase Between Rising Edges measurement, 107
 phase/delay measurements, selecting channels, 99
 PictBridge compliant printer, 123, 124
 PictBridge printer host, USB device port setting, 137
 play-back waveforms, 78, 79
 pollution degree, 140
 Portuguese language, 130
 Positive Duty Cycle measurement, 105
 Positive Pulse Width measurement, 105
 potentiometer adjustment, 38

power cord, 19
 power source, 19
 power supply testing, 38
 power switch, 19
 preferences, setting, 136
 preshoot measurement, 102
 printing data, 123
 probe attenuation, 48
 Probe Comp signal, 21
 programming, remote, 125
 pulse width trigger, 85, 86

Q

quick help, 130

R

random noise, 74
 real-time sampling mode, 71
 recalling data, 114
 record waveforms, 78
 recorded waveforms, storing, 81
 recording waveforms, 78
 Rectangle FFT window, 55
 reference, 44
 reference level for vertical scaling, 136
 reference waveform, saving, 57
 reference waveforms, 42, 57
 reference waveforms, export or import, 57
 refresh rate, 3, 75
 remote program, 84
 remote programming, 125
 required oscilloscope bandwidth, 70
 Rise Time measurement, 104
 rise time, oscilloscope, 69
 rise time, signal, 70
 Rmt on oscilloscope display, 84
 Roll time base, 41
 Run Control keys, 31
 Run/Stop key, 31
 Russian language, 130

S

safety
 notices, 151
 symbols, 152
 sample rate, 3, 42
 sample rate and memory depth, 72
 sample rate, oscilloscope, 67, 69
 sampling rate, 41
 sampling theory, 66
 sampling, overview, 66
 save data to CSV format files, 117
 save screens to BMP or PNG files, 116
 Save/Recall key, 114
 saving data, 114
 screen colors, invert, 62
 screen persistence, 63
 screen refresh rate, 75
 screen saver, 136
 screens, saving to BMP or PNG files, 116
 SECAM standard, 87, 88
 self-calibration, 138
 sensitivity, trigger, 94
 sensitivity, Volts/Div control, 50
 serial number, 128
 setups, saving and loading, 115
 shipping container, 18
 Simplified Chinese language, 130
 sine(x)/x interpolation, 38, 77
 Single key, 31
 Slow Scan mode, 38
 softkeys, 28
 software version, 128
 sound, turning on/off, 128
 Spanish language, 130
 specifications, 142
 square waves, 68
 status bar, 37
 store recorded waveforms, 81
 subtract math function, 53
 subtract waveforms, 54
 sweep speed, 37
 symbols, safety, 152

Index

system information, displaying, 128

T

temperature at last calibration, 142
theory, sampling, 66
time measurements, 3, 42, 103, 109
Track cursor measurements, 109
tracking cross-hair cursors, 111
Traditional Chinese language, 130
transducer monitoring, 38
transient withstand capability, 141
trigger controls, 42
trigger coupling, 92
trigger high-frequency reject coupling, 93
trigger holdoff, 95
trigger holdoff, reset, 95
trigger level, 83, 108
trigger mode, 85
trigger position, 37
trigger sensitivity, 94
trigger sweep, 91, 92
trigger system controls, 83
triggering, 3

U

under-sampled signals, 66
units, channel, 52
unknown units, 52
untriggered sample acquisition mode, 41
USB device port, 123
USB Device port function, 137
USB ports, 3
Utility key, 127

V

Vamp (amplitude voltage = $V_{top} - V_{base}$)
measurement, 101
Vavg (average voltage) measurement, 101
Vbase (base voltage) measurement, 101
vectors, 42
vectors waveform type, 59
vernier adjustment, 44, 50

vertical failure margin (mask), 134
vertical position, 44
vertical position knob, 43, 44
vertical scale, 44
vertical scale knob, 43, 44, 50
vertical scale reference level, 136
vertical scaling, 48
vibration, analyzing, 54
video trigger, 85, 87
Vmax (maximum voltage)
measurement, 100
Vmin (minimum voltage)
measurement, 101
volt units, 52
voltage measurements, 3, 42, 100, 109
Volts/Div control sensitivity, 50
Vpp (peak-to-peak voltage)
measurement, 101
Vrms (root-mean-square voltage)
measurement, 102
Vtop (top voltage) measurement, 101

W

warnings, 151
watt units, 52
waveform intensity, 60
waveform intensity, graded, 61
waveform math, 53
waveform persistence, 60
waveforms, recording/playing-back, 3, 78
waveforms, turning on or off, 43
window, FFT, 55

X

X-Y format, 41
X-Y time base, 40

Y

Y-T time base, 40

Z

zoomed time base, 39

zoomed time base display, 42

www.agilent.com

© Agilent Technologies, Inc. 2008-2009

Printed in Malaysia 10/09
Second Edition, October 2009



54130-97014



Agilent Technologies